

10"

Architectural LED Cylinder

EPC-10-CM

Cylinder Series



Application

A complete family of cylinders for downlight, wallwashers, double wallwashers, and corner wallwashers in multiple, mounting options, beam spreads and apertures designed for commercial, civic, museums, corporate, hospitality, academic, retail, medical, and houses of worship.

Features

- Exceptional Optical Quality: Up to 98 CRI, 1x2 Step MacAdam Ellipse.
- Shipped standard with a Solite Beam Smoother lens that removes striations from the light source.
- Available with a multitude of dimming protocols and control offerings.

Nominal Lumens	Delivered Lumens	Wattage
900L	1091	12
1200L	1439	16
1500L	1782	22
2000L	2382	28
3000L	3512	44
4000L	4638	48
6000L	6412	78

Based on 4000K, 90+ CRI with semi-specular chrome reflector. Actual wattage may vary +/-5%



Lumens	High Performance: 900, 1200, 1500, 2000, 3000, 4000, 6000, 8000 Dims to Warm: 900, 1200, 1500, 2000 Xicato Artist: 900, 1200, 1500, 2000, 3000 Natural Spectrum: 900, 1200, 1500, 2000, 3000
CCT & Dynamic Platforms	High Performance: 22K, 27K, 30K, 35K, 40K, 50K Dims to Warm: 30K-18K, 30K-22K, 27K-18K Xicato Artist: 27K, 30K, 30K-VIB, 35K, 40K Natural Spectrum: 27K, 30K, 35K, 40K, 50K, 65K
CRI	High Performance: 90+, 98+ Dims to Warm: 90+ Xicato Artist: 98+ Natural Spectrum: 97+
Color Quality	2 Step MacAdam Ellipse
Distributions	NSPD (Narrow Spot 15°), SPD (Spot 24°), ND (Narrow 30°), MD (Medium 36°), MWD (Medium Wide 52°), WD (Wide 60°), VWD (Very Wide 70°)
Trim Options	Downlight, Wall Wash, Double Wall Wash, Corner Wall Wash, Wet Location
Reflector Colors	CL (Semi-Specular Chrome), SHZ (Low Iridescent Satin Haze), WT (Wheat), W (White), MB (Black), BZ (Bronze)
Flange Colors	Self-Flanged WH (White), SCH (Semi-Specular Chrome), SHZ (Low Iridescent Satin Haze), BK (Black), BZ (Bronze)
Dimming	DIM10, LUTH, LUTFTB, ELDO10.1-LIN, ELDODMX.1, ELDODALI.1, DIMTR, BLE-CASAMBI, POE, DIM10-0-OFF, ELDO10-LOG, XSR, DIM10-AUX
Emergency	EMG-LED-10W, EMG-LED-20W, INTG-EMG-LED-10W, INTG-EMG-LED-20W, EMG-LED-G2-10W-SDT
Lifetime	L70 at 102,000 Hours
Photometric Tests	In Accordance with IES LM79-08, LM80 and TM-30, TM-21



10"

Architectural LED Cylinder

EPC-10-CM

Cylinder Series

PART NUMBER: **EPC-10-CM-900L-22K-90-NSPD-DIM10-120V**

Series	Lumens	CCT	CRI	Optics	Driver	Voltage	Emergency
EPC-10-CM	900L 1200L 1500L 2000L 3000L 4000L 6000L 8000L⁶	22K 27K 30K 35K 40K 50K¹	90+ 98+²	NSPD Narrow Spot (15°) SPD Spot (24°) ND Narrow (30°) MD Medium (36°) MWD Medium Wide (52°) WD Wide (60°) VWD Very Wide (70°)	DIM10 LUTH LUTFTB⁴ ELDO10.1-LIN ELDODMX.1 ELDODALI.1 DIMTR³ BLE-CASAMBI POE DIM10-0-OFF ELDO10-LOG XSR DIM10-AUX	120V 277V MVOLT 347V⁵	- EMG-LED-10W EMG-LED-20W INTG-EMG-LED-10W INTG-EMG-LED-20W EMG-LED-G2-10W-SDT

¹ 50K series are available with 85+ CRI only ² 98+ CRI is available in 27K, 30K and 40K only ³ DIMTR available for luminaires up to 4000L in 120V only ⁴ LUTFTB Available for luminaires up to 1500L ⁵ 347V is available in only DIM10 ⁶ The 8000L is available in only DIM10

PART NUMBER: **EPC-10-CM-WDM-30K-18K-900L-90-NSPD-DIMTR-120V**

Series	Technology	Lumens	CRI	Optics	Driver	Voltage	Emergency
EPC-10-CM-WDM <i>(Dim to Warm)</i>	30K-18K 30K-22K 27K-18K	900L 1200L 1500L 2000L	90+	NSPD Narrow Spot (15°) SPD Spot (24°) ND Narrow (30°) MD Medium (36°) MWD Medium Wide (52°) WD Wide (60°) VWD Very Wide (70°)	DIMTR¹ DIM10 LUTH ELDO10.1 ELDODALI.1 ELDODMX.1	120V 277V MVOLT 347V²	- EMG-LED-10W EMG-LED-20W INTG-EMG-LED-10W INTG-EMG-LED-20W EMG-LED-G2-10W-SDT

¹ DIMTR available in 120V only ² 347V is available in only DIM10

10"

Architectural LED Cylinder

EPC-10-CM

Cylinder Series

PART NUMBER: EPC-10-CM-XIA-900L-27K-98-NSPD-DIM10-120V

Series	Lumens	CCT	CRI	Optics	Driver	Voltage	Emergency
EPC-10-CM-XIA <i>(Xicato Artist)</i>	900L 1200L 1500L 2000L 3000L	27K 30K 30K-VIB 35K 40K	98+	NSPD Narrow Spot (15°) SPD Spot (24°) ND Narrow (30°) MD Medium (36°) MWD Medium Wide (52°) WD Wide (60°) VWD Very Wide (70°)	DIM10 LUTH LUTFTB⁴ ELDO10.1-LIN ELDODMX.1 ELDODALI.1 DIMTR³ BLE-CASAMBI POE DIM10-0-OFF ELDO10-LOG XSR DIM10-AUX	120V 277V MVOLT 347V ³	- EMG-LED-10W EMG-LED-20W INTG-EMG-LED-10W INTG-EMG-LED-20W EMG-LED-G2-10W-SDT

¹ DIMTR available in 120V only ² LUTFTB Available for luminaires up to 1500L ³ 347V is available in only DIM10

PART NUMBER: EPC-10-CM-NSL-900L-27K-97-NSPD-DIM10-120V

Series	Lumens	CCT	CRI	Optics	Driver	Voltage	Emergency
EPC-10-CM-NSL <i>(Natural Spectrum)</i>	900L 1200L 1500L 2000L 3000L	27K 30K 35K 40K 50K 65K	97+	NSPD Narrow Spot (15°) SPD Spot (24°) ND Narrow (30°) MD Medium (36°) MWD Medium Wide (52°) WD Wide (60°) VWD Very Wide (70°)	DIM10 LUTH LUTFTB⁴ ELDO10.1-LIN ELDODMX.1 ELDODALI.1 DIMTR³ BLE-CASAMBI POE DIM10-0-OFF ELDO10-LOG XSR DIM10-AUX	120V 277V MVOLT 347V ³	- EMG-LED-10W EMG-LED-20W INTG-EMG-LED-10W INTG-EMG-LED-20W EMG-LED-G2-10W-SDT

¹ DIMTR available in 120V only ² LUTFTB Available for luminaires up to 1500L ³ 347V is available in only DIM10















10"

Architectural LED Cylinder

EPC-10-CM

Cylinder Series

ORDER GUIDE

REFLECTOR TYPE				MOUNTING	COLOR				
REFLECTOR TYPE				MOUNTING	COLOR				
					ANODIZED FLANGED				
Open Downlight EPD-10-101	Wall Wash EPD-10-107	Double Wall Wash EPD-10-177	Corner Wall Wash EPD-10-127	Flanged 	Clear White CL-WH 	Satin Haze White SHZ-WH 	Black BK-BK 		
					Clear Semi-Spec CL-SCH 	White WH-WH 	Satin Haze SHZ-SHZ 		
					Clear Black CL-BK 	Black White BK-WH 	Wheat White WT-WH 		
					ANODIZED TRIMLESS				
Open Downlight EPD-10-TL-101	Wall Wash EPD-10-TL-107			Trimless 	White WH 	Black BK 	Clear CL 	Satin Haze SHZ 	



10"

Architectural LED Cylinder

EPC-10-CM

Cylinder Series

Modifications Available

Consult factory for modification requests; orders may require shop drawing approval.

Downlight

Our signature anodized reflector, spun to a reverse parabola design, achieves a 50° shielding angle and a 40° cut-off, which eliminates inter-reflections, and enhances low aperture brightness

Wall Wash

The optical assembly delivers uniform ceiling-to-floor wallwashing without creating any visible scallops. The optical assembly is specially designed to extend a beam in two directions for a uniform floor-to-ceiling and side-to-side wash of light.

Double Wall Wash

Used in a corridor to wash both walls, providing both horizontal and vertical illumination that fully illuminates corridors and hallways.

Corner Wall Wash

Replacing the effect that two luminaires provide, a corner wallwasher kicks light across corners that run perpendicular to one another, ultimately providing a 210° wash of light fully covering conjoined walls and surfaces.

Optical Performance and Trim

Spun aluminum anodized single piece reflector. The optical system consists of 1) an upper reflector for a precise beam spread; 2) a solite soft focus lens to diffuse the light source for smooth, striation-free distribution; 3) and a patented lens to control the beam angle and provide a 40° visual cutoff. Available in a variety of beam angles. Integral heatsink comes preinstalled on the housing for maximum heat dissipation and locks together with the reflector to prevent zero light leakage for above the ceiling.

Fully Servicable - Easy Installation & Upgrading

Ceiling mount bracket provided for direct installation with 3-1/4" to 4" octagonal and square junction box.

Housing / Mounting

Die-formed constructed cylinder body for maximum heat dissipation and rust protection. Cylinder is available in a variety of post painted colors and custom RAL colors.

Emergency Options/Controls

The Emergency battery pack needs to be remote mounted in a junction above the ceiling. A custom made canopy can also be provided upon request when there is no ceiling access and the emergency needs to be mounted below the ceiling line. The test switch for the emergency battery is mounted remotely (EMG-LED option) on the ceiling. Self Diagnostic emergency option available (EMG-SDT) Typical lumen output of the luminaire is up to 1000L with EMG-LED-10W option & 2000L with EMG-LED-20W option in emergency mode. Other accessories and controls systems include modular wiring systems, daylight harvesting controls, occupancy sensors, and/or power packs for individual or room control applications.

Drivers

120/277V 50/60Hz; 347V available. THD < 20%; power factor >.09. Thermally protected. Removal of the reflector provides complete accessibility to the junction box, driver and internal components from above and below the ceiling through the aperture.

Dim to Warm Option

Dim to Warm simulates traditional incandescent halogen lighting through dimming. When the luminaire dims to warm from 100% to .1%, it makes a smooth transition across the black body radiator while maintaining a constant CRI of 90+. Available in 30K-18K, 30K-22K or 27K-18K range.

Xicato Artist Series LED Module (XIA)

Powered by Xicato Artist Series®, which are tested to IES TM-30-15, with a color fidelity score (Rf) of 96 and a color gamut score (Rg) of 102, and color shift less than du'v' of 0.003. Featuring cold phosphor technology, improving thermal management enhancing color consistency and delaying lumen depreciation.

Natural Spectrum (NSL)

Natural Spectrum LED option is designed for Human Centric lighting application. Natural Spectrum LEDs diminish blue light peak, similar spectral curve to sunlight, accurate rendering of colors and reduced scattered reflection and glare.

Dimming & Driver Information

DIM10 - 0-10V dimming on either MVOLT 120, 277 or 347V. Dimmable down to 1% of initial lumens, standard

LUTH - Lutron LDE1 Hi-Lume Eco System with Soft Fade to Black 1% dimming

LUTFTB - Lutron PEQO Hi-Lume Premier Eco System LED Driver with soft-on fade to black 0.1% dimming

ELDO10.1-LIN - ELDO10-Linear with linear dimming curve.

ELDODMX.1 - EldoLED PowerDrive dimming down to 0.1%. Please see EldoLED website for wiring diagrams and a list of compatible DMX and DALI control systems.

ELDODALI.1 - EldoLED SoloDrive DALI-2. Dimming down to 0.1%

DIMTR - Triac & Electronic low voltage forward phase dimming. Available in 120V only

BLE-CASAMBI - Luminaires may be controlled, grouped, scheduled or placed in scenes, and or zones Via Casambi Bluetooth 4.0 App.

POE - Power-over-Ethernet Depending on the PoE manufacturer selected

DIM10-0-OFF - Program DIM10-to OFF with linear dimming curve 0.1%

ELDO10-LOG - ELDO10-LOG with logarithmic dimming curve.

XSR - Xitanium SR Dimming

DIM10-AUX - 0-10V with Auxiliary power

ELDO10.1 - EldoLED SoloDrive 0-10V. Dimming down to 0.1%



10"

Architectural LED Cylinder

EPC-10-CM

Cylinder Series

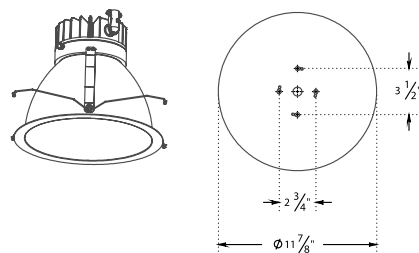
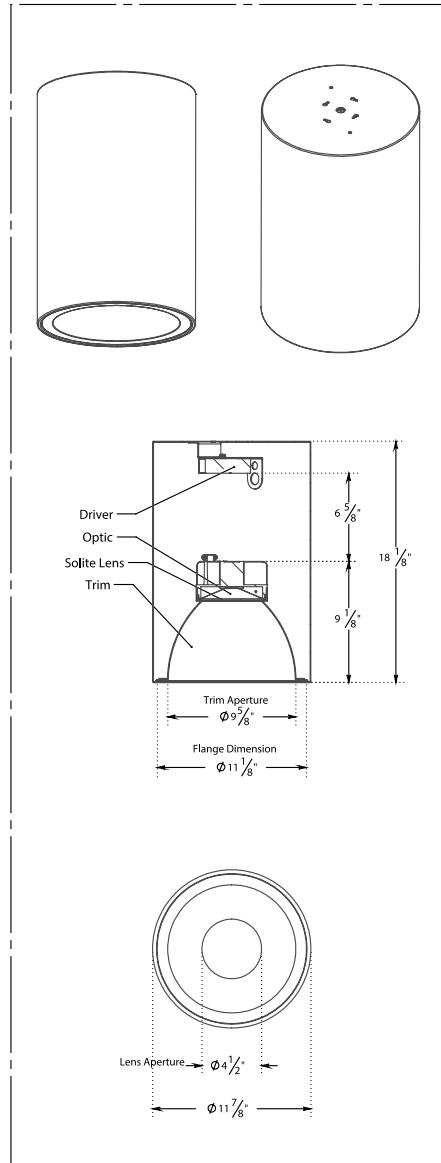

10"

Architectural LED Cylinder

EPC-10-CM

Cylinder Series

EPC-10-CM-4000L-40K-90-VWD-DIM10-MVOLT-EPD-10-101

TEST NO.: EL052522137

INPUT WATTS: 41.0

LUMENS: 3909

EFFICACY: 95

BEAM ANGLE: 48

SPACING CRITERIA: 0.69 x 0.69

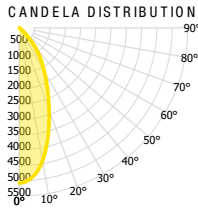

CANDELA TABLE

	0°	90°
0°	5078	5078
10°	4408	4387
20°	2864	2899
30°	1637	1673
40°	791	833
50°	124	137
60°	8	8
70°	3	3
80°	1	1
90°	0	0

LUMINANCE (cd/sq.m)

	0.00°	90.00°
0.00°	108742	108742
45.00°	11563	12884
55.00°	725	1043
65.00°	256	257
75.00°	137	139
85.00°	54	44

LUMENS PER ZONE

ZONE	LUMENS
0° - 10°	461
10° - 20°	1068
20° - 30°	1098
30° - 40°	834
40° - 50°	390
50° - 60°	49
60° - 70°	6
70° - 80°	2
80° - 90°	0

ZONAL LUMEN SUMMARY

ZONE	UMENS	% LUMINAIRE
0° - 20°	1529	39%
0° - 30°	2627	67%
0° - 40°	3460	89%
0° - 60°	3899	100%
0° - 80°	3907	100%
0° - 90°	3908	100%

CONE OF LIGHT

MOUNTING HEIGHT	FC AT BEAM CENTER	BEAM DIA. 0°-180°	BEAM DIA. 90°-270°
6.0 ft	141.1 fc	5.3 ft	5.3 ft
8.0 ft	79.3 fc	7.1 ft	7.1 ft
10.0 ft	50.8 fc	8.8 ft	8.8 ft
12.0 ft	35.3 fc	10.6 ft	10.6 ft
14.0 ft	25.9 fc	12.4 ft	12.3 ft
16.0 ft	19.8 fc	14.1 ft	14.1 ft
18.0 ft	15.7 fc	15.9 ft	15.9 ft
20.0 ft	12.7 fc	17.7 ft	17.6 ft

INDOOR COEFFICIENTS OF UTILIZATION

ρ _f	80%				70%				20%				0%			
	ρ _w	70%	50%	30%	10%	70%	50%	30%	10%	50%	30%	10%	50%	30%	10%	0%
0	119	119	119	119	119	116	116	116	111	111	106	106	106	102	102	100
1	113	111	108	106	111	108	106	104	104	103	101	101	99	98	97	95
2	108	103	99	95	106	101	97	94	98	95	92	95	92	90	92	88
3	102	96	91	87	100	94	90	86	92	88	85	89	86	83	87	84
4	97	89	84	79	95	88	83	79	86	82	78	84	80	77	82	76
5	92	83	78	73	90	83	77	73	81	76	72	79	75	72	77	71
6	87	78	72	68	86	77	72	68	76	71	67	75	70	67	73	66
7	83	73	67	63	82	73	67	63	72	66	63	70	66	62	69	65
8	79	69	63	59	78	69	63	59	68	62	59	66	62	58	66	61
9	75	65	59	55	74	65	59	55	64	59	55	63	58	55	62	58
10	72	62	56	52	71	61	56	52	61	55	52	60	55	52	59	55

