

# 8"

# EPC-8-PM-RGBW

## Architectural LED Cylinder

## Cylinder Series



### Application

A complete family of cylinders for downlight, wallwashers, double wallwashers, and corner wallwashers in multiple, mounting options, beam spreads and apertures designed for commercial, civic, museums, corporate, hospitality, academic, retail, medical, and houses of worship.

### Features

- Exceptional Optical Quality: Up to 98 CRI, 1x2 Step MacAdam Ellipse.
- Shipped standard with a Solite Beam Smoother lens that removes striations from the light source.
- Available with a multitude of dimming protocols and control offerings.

Nominal Lumens	Delivered Lumens	Wattage
900L	852	12
1200L	1098	16
1500L	1421	20
2000L	1925	27

Based on 4000K, 90+ CRI with semi-specular chrome reflector. Actual wattage may vary +/-5%

<b>Lumens</b>	<b>Tunable White:</b> 900, 1200, 1500, 2000, 3000, 4000 <b>RGB + White:</b> 1100, 2000
<b>CCT &amp; Dynamic Platforms</b>	<b>Tunable White:</b> 50K-27K, 65K-27K <b>RGB + White:</b> LENGN-65K-18K
<b>CRI</b>	90+
<b>Color Quality</b>	2 Step MacAdam Ellipse
<b>Distributions</b>	NSPD (Narrow Spot 15°), SPD (Spot 24°), ND (Narrow 30°), MD (Medium 36°), MWD (Medium Wide 52°), WD (Wide 60°), VWD (Very Wide 70°)
<b>Trim Options</b>	Downlight, Wall Wash, Double Wall Wash, Corner Wall Wash, Wet Location
<b>Reflector Colors</b>	CL (Semi-Specular Chrome), SHZ (Low Iridescent Satin Haze), WT (Wheat), W (White), MB (Black), BZ (Bronze)
<b>Flange Colors</b>	Self-Flanged WH (White), SCH (Semi-Specular Chrome), SHZ (Low Iridescent Satin Haze), BK (Black), BZ (Bronze)
<b>Dimming</b>	<b>Tunable White:</b> DIM10, DMX-512, DMX-RDM, DALI, BLE, LUTH <b>RGB + White:</b> ELDODMX.1
<b>Emergency</b>	<b>Tunable White:</b> EMG-LED-10W, EMG-LED-20W, INTG-EMG-LED-10W, INTG-EMG-LED-20W, EMG-LED-G2-10W-SDT <b>RGB + White:</b> PELI-S-20, PELI-S-100, PELI-S-250, PELI-S-400
<b>Lifetime</b>	L70 at 102,000 Hours
<b>Photometric Tests</b>	In Accordance with IES LM79-08, LM80 and TM-30, TM-21



# 8"

# EPC-8-PM-RGBW

## Architectural LED Cylinder

## Cylinder Series

PART NUMBER: **EPC-8-PM-TWH-50K-27K-900L-90-NSPD-DIM10-120V-PM12**

Series	Technology	Lumen	CRI	Optics	Driver	Voltage	Emergency	Mounting	Accessories
<b>EPC-8-PM-TW</b> <small>(Tunable White)</small>	<b>50K-27K</b> <b>65K-27K</b>	<b>900L</b> <b>1200L</b> <b>1500L</b> <b>2000L</b> <b>3000L</b> <b>4000L</b>	<b>90+</b>	<b>NSPD</b> <small>Narrow Spot (15°)</small> <b>SPD</b> <small>Spot (24°)</small> <b>ND</b> <small>Narrow (30°)</small> <b>MD</b> <small>Medium (36°)</small> <b>MWD</b> <small>Medium Wide (52°)</small> <b>WD</b> <small>Wide (60°)</small> <b>VWD</b> <small>Very Wide (70°)</small>	<b>DIM10</b> <b>DMX-512</b> <b>DMX-RDM</b> <b>DALI</b> <b>BLE</b> <b>LUTH</b>	<b>120V</b> <b>277V</b> <b>MVOLT</b>	- <b>EMG-LED-10W</b> <b>EMG-LED-20W</b> <b>INTG-EMG-LED-10W</b> <b>INTG-EMG-LED-20W</b> <b>EMG-LED-G2-10W-SL</b>	<b>PM12</b> <b>PM18</b> <b>PM24</b> <b>PM36</b> <b>PM48</b> <b>SM10</b>	- <b>EC-WC-TWH-HW-MVOLT</b> <small>Dual-channel touch screen wall controller with tunable white technology, supporting 0-10V dimming.</small>

**1** For DIM10 driver you must dedicate two control inputs, one for the Dimming Control and another for CCT Tuning  
**2** Lutron is the T-Series 2-Channel Tunable White EcoSystem

PART NUMBER: **EPC-8-PM-RGBW-LENGN-65K-18K-1100L-90-NSPD-ELDODMX.1-120V-PM12**

Series	Technology	Lumens	CRI	Optics	Driver	Voltage	Emergency	Mounting
<b>EPC-8-PM-RGBW</b> <small>(RGB + White)</small>	<b>LENGN-65K-18K</b>	<b>1100L</b> <b>2000L</b>	<b>90+</b>	<b>NSPD</b> <small>Narrow Spot (15°)</small> <b>SPD</b> <small>Spot (24°)</small> <b>ND</b> <small>Narrow (30°)</small> <b>MD</b> <small>Medium (36°)</small> <b>MWD</b> <small>Medium Wide (52°)</small> <b>WD</b> <small>Wide (60°)</small> <b>VWD</b> <small>Very Wide (70°)</small>	<b>ELDODMX.1</b>	<b>120V</b> <b>277V</b> <b>MVOLT</b>	- <b>PELI-S-20</b> <b>PELI-S-100</b> <b>PELI-S-250</b> <b>PELI-S-400</b>	<b>PM12</b> <b>PM18</b> <b>PM24</b> <b>PM36</b> <b>PM48</b> <b>SM10</b>

**Note:** All extra optical accessories, aperture assemblies, and optics can be ordered separately. Check EPL Website for ordering nomenclature.

























# 8"

## Architectural LED Cylinder

# EPC-8-PM-RGBW

## Cylinder Series

### ORDER GUIDE

REFLECTOR TYPE				MOUNTING	COLOR				
REFLECTOR TYPE				MOUNTING	COLOR				
Open Downlight EPD-8-801	Wall Wash EPD-8-807	Double Wall Wash EPD-8-877	Corner Wall Wash EPD-8-827	Flanged 	ANODIZED FLANGED				
					Clear White CL-WH 	Clear Bronze CL-BZ 	Black White BK-WH 	Satin Haze SHZ-SHZ 	Wheat WT-WT 
					Clear Semi-Spec CL-SCH 	Satin Haze White SHZ-WH 	Black BK-BK 	Satin Haze Black SHZ-BK 	
					Clear Black CL-BK 	White WH-WH 	Bronze BZ-BZ 	Wheat White WT-WH 	
Open Downlight EPD-8-TL-801	Wall Wash EPD-8-TL-807			Trimless 	ANODIZED TRIMLESS				
					White WH 	Black BK 	Clear CL 	Satin Haze SHZ 	



# 8"

## Architectural LED Cylinder

# EPC-8-PM-RGBW

## Cylinder Series

### Modifications Available

Consult factory for modification requests; orders may require shop drawing approval.

### Downlight

Our signature anodized reflector, spun to a reverse parabola design, achieves a 50° shielding angle and a 40° cut-off, which eliminates inter-reflections, and enhances low aperture brightness

### Wall Wash

The optical assembly delivers uniform ceiling-to-floor wallwashing without creating any visible scallops. The optical assembly is specially designed to extend a beam in two directions for a uniform floor-to-ceiling and side-to-side wash of light.

### Double Wall Wash

Used in a corridor to wash both walls, providing both horizontal and vertical illumination that fully illuminates corridors and hallways.

### Corner Wall Wash

Replacing the effect that two luminaires provide, a corner wallwasher kicks light across corners that run perpendicular to one another, ultimately providing a 210° wash of light fully covering conjoined walls and surfaces.

### Optical Performance and Trim

Spun aluminum anodized single piece reflector. The optical system consists of 1) an upper reflector for a precise beam spread; 2) a solite soft focus lens to diffuse the light source for smooth, striation-free distribution; 3) and a patented lens to control the beam angle and provide a 40° visual cutoff. Available in a variety of beam angles. Integral heatsink comes preinstalled on the housing for maximum heat dissipation and locks together with the reflector to prevent zero light leakage for above the ceiling.

### Fully Servicable - Easy Installation & Upgrading

Pendant mount option is supplied with a 5" diameter canopy cover. Suspended mount option is supplied with an aircraft adjustable cable, and is ideal for sloped ceiling applications up to 45 degrees.

### Housing / Mounting

Die-formed constructed cylinder body for maximum heat dissipation and rust protection. Cylinder is available in a variety of post painted colors and custom RAL colors.

### Emergency Options/Controls

The Emergency battery pack needs to be remote mounted in a junction above the ceiling. A custom made canopy can also be provided upon request when there is no ceiling access and the emergency needs to be mounted below the ceiling line. The test switch for the emergency battery is mounted remotely (EMG-LED option) on the ceiling. Self Diagnostic emergency option available (EMG-SDT) Typical lumen output of the luminaire is up to 1000L with EMG-LED-10W option & 2000L with EMG-LED-20W option in emergency mode. Other accessories and controls systems include modular wiring systems, daylight harvesting controls, occupancy sensors, and/or power packs for individual or room control applications.

### Drivers

RGB+White platform with tuning range of 6500K to 1650K, Saturation and Hue Gradients of color can be added in increments of 1% to fully saturated colors at 100% enabling gamut access to pastels and saturated colors (RGBW- 65K-16K). Control via, DMX-512/RDM.

### Tunable White Option

Tunable White allows the luminaires to be color tuned via various controls. Create the perfect environment for the desired use of the space or mimic the natural color patterns throughout the day and stimulate circadian rhythm. Available in tuning range of 50K-27K (TWH-50K-27K), 65K-27K (TWH-65K-27K), 65K-18K (TWH-LENGN-65K-18K).

### RGB + White Option

Refine your space with Mood Master (RGBW & TW), which provides complete control over hue, color temperature, saturation, and dimming for design versatility. RGB + White technology has a white color tuning range from 6500K to 1650K. RGB color range derived from the primary colors red, green and blue is used to create infinite color options in the RGB palette, adding colors together in varying amounts to create new ones. RGB Tunable White technology enables users to adjust the color temperature, adding gradients of saturated colors. No longer restricted to white light LEDs, lighting designers and architects can manipulate a space with desired hues and shades, altering the color temperature of the room, creating the perfect environment. The use of RGB Tunable White technology in allows infinite possibilities for any application

### Dimming & Driver Information

**DIM10** - 0-10V dimming on either MVOLT 120, 277 or 347V. Dimmable down to 1% of initial lumens, standard

**DMX-512** - EldoLED PowerDrive dimming down to 0.1%. Please see EldoLED website for wiring diagrams and a list of compatible DMX and DALI control systems.

**DMX-RDM** - EldoLED PowerDrive dimming down to 0.1%. Please see EldoLED website for wiring diagrams and a list of compatible DMX and DALI control systems.

**DALI** - EldoLED SoloDrive DALI-2. Dimming down to 0.1%

**BLE** - Bluetooth Casambi enabled controllable

**LUTH** - Lutron LDE1 Hi-Lume Eco System with Soft Fade to Black 1% dimming

**ELDODMX.1** - EldoLED PowerDrive dimming down to 0.1%. Please see EldoLED website for wiring diagrams and a list of compatible DMX and DALI control systems.



8"

EPC-8-PM-RGBW

Architectural LED Cylinder

Cylinder Series

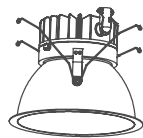
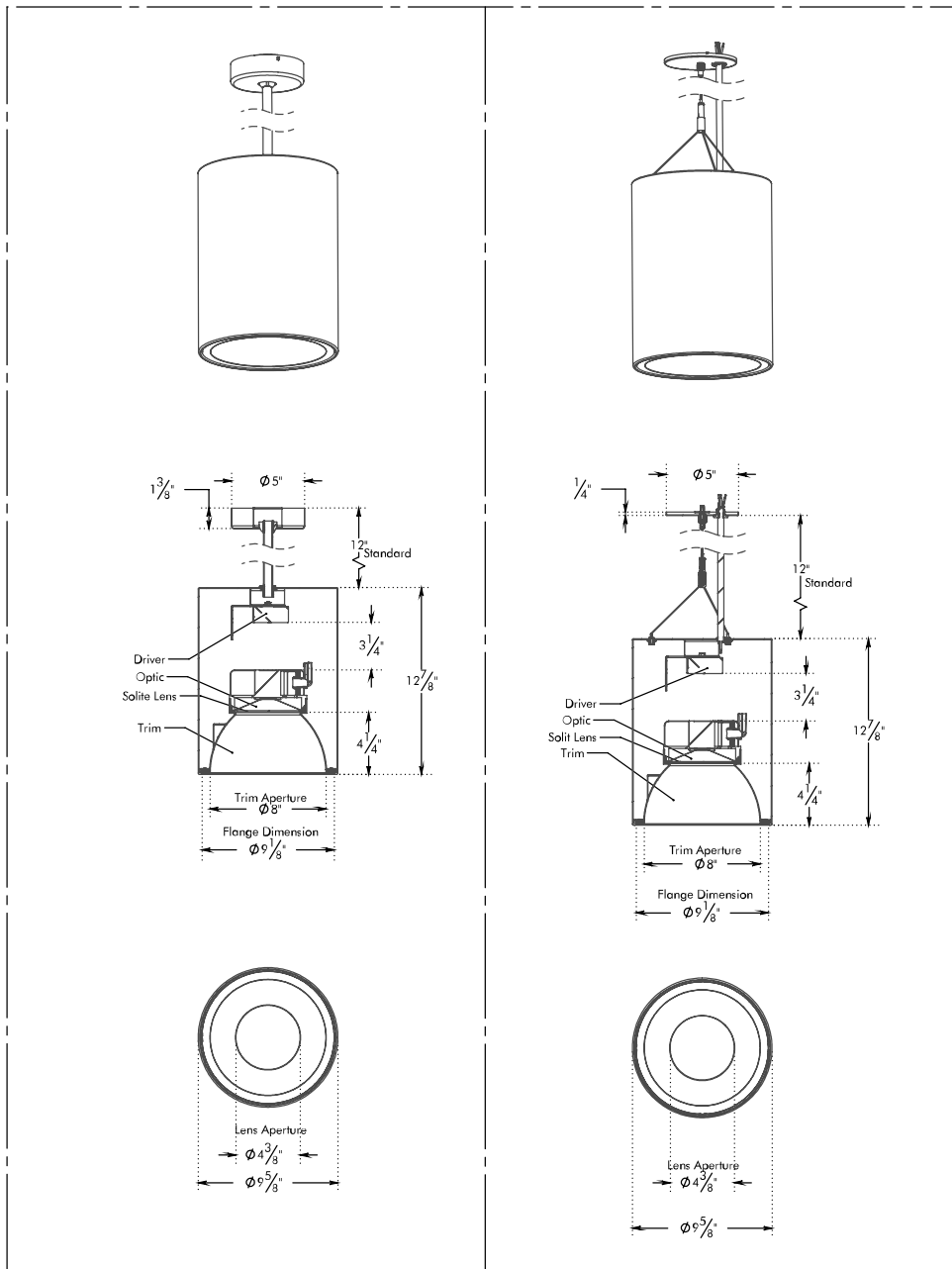

HH8-8501