

# 3"

# EPD-3-SHAL-IC-ADJ

Architectural LED Downlight- Shallow, IC Rated, Adjustable

**Edison Series**

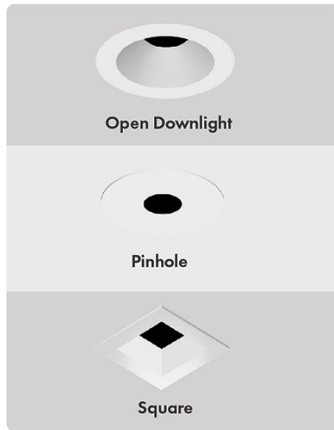

### Application

A compact architectural downlight expertly crafted to deliver top-notch quality and uncompromising performance. This fixture offers precise, glare-free illumination and exceptional flexibility. With a single universal housing, it seamlessly accommodates a range of trims and allows for field-changeable optics.

### Features

- Full adjustability for beam angles, up to 45 degrees
- Horizontal rotation of up to 365 degrees
- Suitable for high-end architectural, hospitality, commercial, residential, and retail spaces
- The EPD-3 is the cutting-edge solution for small aperture design applications

Nominal Lumens	Delivered Lumens	Wattage
700L	881	10
900L	1037	12
1200L	1392	16

Based on 4000K, 90+ CRI with semi-specular chrome reflector. Actual wattage may vary +/-5%

<b>Lumens</b>	<b>High Performance:</b> 700, 900, 1200 <b>Dims to Warm:</b> 900, 1200 <b>Xicato Artist:</b> 900, 1200 <b>Natural Spectrum:</b> 900, 1200
<b>CCT &amp; Dynamic Platforms</b>	<b>High Performance:</b> 27K, 30K, 35K, 40K, 50K <b>Dims to Warm:</b> 30K-18K, 30K-22K, 27K-18K <b>Xicato Artist:</b> 27K, 30K, 30K-VIB, 35K, 40K <b>Natural Spectrum:</b> 27K, 30K, 35K, 40K, 50K, 65K
<b>CRI</b>	<b>High Performance:</b> 90+, 98+ <b>Dims to Warm:</b> 90+ <b>Xicato Artist:</b> 98+ <b>Natural Spectrum:</b> 97+
<b>Color Quality</b>	2 Step MacAdam Ellipse
<b>Distributions</b>	SPD (Spot 15°), ND (Narrow 24°), MD (Medium 35°), MWD (Medium Wide 45°), WD (Wide 52°)
<b>Trim Options</b>	Downlight, Lensed Downlight, Adjustable, Lensed Wall Wash, Slot, Pinhole, Self Flanged, Trim-less, Square
<b>Reflector Colors</b>	CL (Semi-Specular Chrome), SHZ (Low Iridescent Satin Haze), WH (White), BK (Black)
<b>Flange Colors</b>	WH (Self-Flanged White)
<b>Dimming</b>	DIM10, LUTH, LUTFTB, ELDO10.1-LIN, ELDODMX.1, ELDODALI.1, DIMTR, BLE-CASAMBI, POE, DIM10-0-OFF, ELDO10-LOG, XSR, DIM10-AUX
<b>Emergency</b>	EMG-LED-10W[(Bodine BSL310)], EMG-LED-20W[(Bodine BSL20)]
<b>Lifetime</b>	L70 at 102,000 Hours
<b>Photometric Tests</b>	In Accordance with IES LM79-08, LM80 and TM-30, TM-21
<b>CCEA Option</b>	For CCEA approved EPD-3 Series, please contact Edison Price Lighting for further information.



# 3"

# EPD-3-SHAL-IC-ADJ

Architectural LED Downlight- Shallow, IC Rated, Adjustable

**Edison Series**

PART NUMBER: **EPD-3-SHAL-IC-ADJ-700L-27K-90-SPD-DIM10-120V**

Series	Lumens	CCT	CRI	Optics	Driver	Voltage	Emergency	Options
<b>EPD-3-SHAL-IC-ADJ</b>	<b>700L</b> <b>900L</b> <b>1200L</b>	<b>27K</b> <b>30K</b> <b>35K</b> <b>40K</b> <b>50K<sup>1</sup></b>	<b>90+</b> <b>98+<sup>2</sup></b>	<b>SPD</b> Spot (15°) <b>ND</b> Narrow (24°) <b>MD</b> Medium (35°) <b>MWD</b> Medium Wide (45°) <b>WD</b> Wide (52°)	<b>DIM10</b> <b>LUTH</b> <b>LUTFTB<sup>4</sup></b> <b>ELDO10.1-LIN</b> <b>ELDODMX.1</b> <b>ELDODALI.1</b> <b>DIMTR<sup>3</sup></b> <b>BLE-CASAMBI</b> <b>POE</b> <b>DIM10-O-OFF</b> <b>ELDO10-LOG</b> <b>XSR</b> <b>DIM10-AUX</b>	<b>120V</b> <b>277V</b> <b>MVOLT</b> <b>347V<sup>5</sup></b>	<b>-</b> <b>EMG-LED-10W</b> <small>(Bodine BSL310)</small> <b>EMG-LED-20W</b> <small>(Bodine BSL20)</small>	<b>-</b> <b>CP<sup>6</sup></b> <b>USA</b>

<sup>1</sup> 50K series are available with 85+ CRI only    <sup>2</sup> 98+ CRI is available in 27K, 30K and 40K only    <sup>3</sup> DIMTR available in 120V only    <sup>4</sup> LUTFTB Available for luminaires up to 1500L    <sup>5</sup> 347V is available in only DIM10    <sup>6</sup> CP Available for luminaires up to 1500L

PART NUMBER: **EPD-3-SHAL-IC-ADJ-WDM-30K-18K-900L-90-SPD-DIMTR-120V**

Series	Technology	Lumens	CRI	Optics	Driver	Voltage	Emergency	Options
<b>EPD-3-SHAL-IC-ADJ-WDM</b> <small>(Dim to Warm)</small>	<b>30K-18K</b> <b>30K-22K</b> <b>27K-18K</b>	<b>900L</b> <b>1200L</b>	<b>90+</b>	<b>SPD</b> Spot (15°) <b>ND</b> Narrow (24°) <b>MD</b> Medium (35°) <b>MWD</b> Medium Wide (45°) <b>WD</b> Wide (52°)	<b>DIMTR<sup>1</sup></b> <b>DIM10</b> <b>LUTH</b> <b>ELDO10.1</b> <b>ELDODALI.1</b> <b>ELDODMX.1</b>	<b>120V</b> <b>277V</b> <b>MVOLT</b> <b>347V<sup>2</sup></b>	<b>-</b> <b>EMG-LED-10W</b> <small>(Bodine BSL310)</small> <b>EMG-LED-20W</b> <small>(Bodine BSL20)</small>	<b>-</b> <b>CP<sup>3</sup></b> <b>USA</b>

<sup>1</sup> DIMTR available in 120V only    <sup>2</sup> 347V is available in only DIM10    <sup>3</sup> CP Available for luminaires up to 1500L

# 3"

# EPD-3-SHAL-IC-ADJ

Architectural LED Downlight- Shallow, IC Rated, Adjustable

## Edison Series

PART NUMBER: **EPD-3-SHAL-IC-ADJ-XIA-900L-27K-98-SPD-DIM10-120V**

Series	Lumens	CCT	CRI	Optics	Driver	Voltage	Emergency	Options
<b>EPD-3-SHAL-IC-ADJ-XIA</b> <i>(Xicato Artist)</i>	<b>900L</b> <b>1200L</b>	<b>27K</b> <b>30K</b> <b>30K-VIB</b> <b>35K</b> <b>40K</b>	<b>98+</b>	<b>SPD</b> Spot (15°) <b>ND</b> Narrow (24°) <b>MD</b> Medium (35°) <b>MWD</b> Medium Wide (45°) <b>WD</b> Wide (52°)	<b>DIM10</b> <b>LUTH</b> <b>LUTFTB<sup>4</sup></b> <b>ELDO10.1-LIN</b> <b>ELDODMX.1</b> <b>ELDODALI.1</b> <b>DIMTR<sup>3</sup></b> <b>BLE-CASAMBI</b> <b>POE</b> <b>DIM10-0-OFF</b> <b>ELDO10-LOG</b> <b>XSR</b> <b>DIM10-AUX</b>	<b>120V</b> <b>277V</b> <b>MVOLT</b> <b>347V<sup>3</sup></b>	<b>-</b> <b>EMG-LED-10W</b> <small>(Bodine BSL310)</small> <b>EMG-LED-20W</b> <small>(Bodine BSL20)</small>	<b>-</b> <b>CP<sup>4</sup></b> <b>USA</b>

**1** DIMTR available in 120V only    **2** LUTFTB Available for luminaires up to 1500L    **3** 347V is available in only DIM10    **4** CP Available for luminaires up to 1500L

PART NUMBER: **EPD-3-SHAL-IC-ADJ-NSL-900L-27K-97-SPD-DIM10-120V**

Series	Lumens	CCT	CRI	Optics	Driver	Voltage	Emergency	Options
<b>EPD-3-SHAL-IC-ADJ-NSL</b> <i>(Natural Spectrum)</i>	<b>900L</b> <b>1200L</b>	<b>27K</b> <b>30K</b> <b>35K</b> <b>40K</b> <b>50K</b> <b>65K</b>	<b>97+</b>	<b>SPD</b> Spot (15°) <b>ND</b> Narrow (24°) <b>MD</b> Medium (35°) <b>MWD</b> Medium Wide (45°) <b>WD</b> Wide (52°)	<b>DIM10</b> <b>LUTH</b> <b>LUTFTB<sup>4</sup></b> <b>ELDO10.1-LIN</b> <b>ELDODMX.1</b> <b>ELDODALI.1</b> <b>DIMTR<sup>3</sup></b> <b>BLE-CASAMBI</b> <b>POE</b> <b>DIM10-0-OFF</b> <b>ELDO10-LOG</b> <b>XSR</b> <b>DIM10-AUX</b>	<b>120V</b> <b>277V</b> <b>MVOLT</b> <b>347V<sup>3</sup></b>	<b>-</b> <b>EMG-LED-10W</b> <small>(Bodine BSL310)</small> <b>EMG-LED-20W</b> <small>(Bodine BSL20)</small>	<b>-</b> <b>CP<sup>4</sup></b> <b>USA</b>

**1** DIMTR available in 120V only    **2** LUTFTB Available for luminaires up to 1500L    **3** 347V is available in only DIM10    **4** CP Available for luminaires up to 1500L





















# 3"

# EPD-3-SHAL-IC-ADJ

Architectural LED Downlight- Shallow, IC Rated, Adjustable

## Edison Series

### ORDERING GUIDE:

REFLECTOR TYPE				MOUNTING	FINISH	
 <b>EPD-3-132</b> Open Downlight	 <b>EPD-3-138</b> Lensed Downlight <small>WET LOCATION</small>	 <b>EPD-3-133</b> Adjustable	 <b>EPD-3-137</b> Lensed Wall Wash <small>WET LOCATION</small>	 Round Flanged	 <b>WH-WH</b> White	 <b>BK-WH</b> Black
 <b>EPD-3-130</b> Slot	 <b>EPD-3-134</b> Pinhole Downlight				 <b>CL-WH</b> Clear Semi-Spec	 <b>SHZ-WH</b> Satin Haze
 <b>EPD-35Q-132</b> Open Downlight	 <b>EPD-35Q-138</b> Lensed Downlight <small>WET LOCATION</small>	 <b>EPD-35Q-133</b> Adjustable	 <b>EPD-35Q-137</b> Lensed Wall Wash <small>WET LOCATION</small>	 Square Flange	 <b>WH-WH</b> White	 <b>BK-WH</b> Black
 <b>EPD-35Q-134</b> Pinhole Downlight					 <b>CL-WH</b> Clear Semi-Spec	 <b>SHZ-WH</b> Satin Haze

**Note:** Consult factory for trimless options

### COLOR FILTERS:



- |               |               |
|---------------|---------------|
| EPD-3-LENS-BL | EPD-3-LENS-YE |
| EPD-3-LENS-GR | EPD-3-LENS-AM |
| EPD-3-LENS-PI | EPD-3-LENS-OR |
| EPD-3-LENS-PU | EPD-3-LENS-RE |
| EPD-3-LENS-DL |               |

### DISTRUBUTION FILTERS:



- |               |                |
|---------------|----------------|
| EPD-3-LENS-FR | EPD-3-LENS-SP  |
| EPD-3-LENS-SF | EPD-3-LENS-HC  |
| EPD-3-LENS-CL | EPD-3-LENS-LI  |
| EPD-3-LENS-UV | EPD-3-LENS-SOL |

**NOTE:** Additional lens filters must only be used on open non-lensed downlight trim options

# 3"

Architectural LED Downlight- Shallow, IC Rated, Adjustable

# EPD-3-SHAL-IC-ADJ

## Edison Series

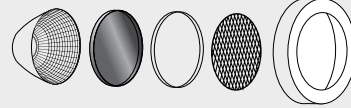
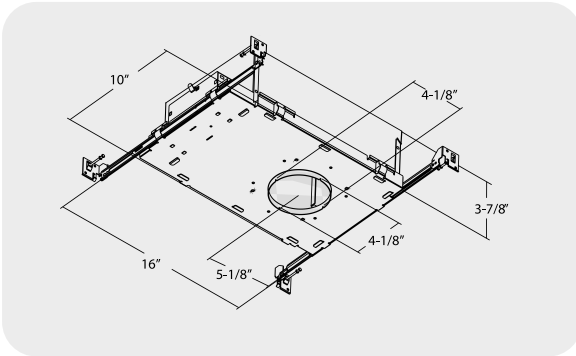

### OPTICS

SPD (15°), ND (24°), MD (35°),  
MWD (45°), WD (52°)

**AIMING**

Our proprietary hot aiming system, which allows for the precise positioning of the lamp to achieve the optimal beam alignment before the trim installation.

Our specially designed lamp holder ensures that the central beam of the light source emerges correctly from the luminaire, accommodating angles from 0° to 45°.

**365° HORIZ. LOCKING**

Seamlessly pivots along a 365-degree horizontal rotation within a sleek slotted groove track system.

**ADJUSTABILITY**

Easy adjustment, without the requirement for tools, allows the luminaire to be positioned at angles of up to 45 degrees, ensuring optimal beam direction and maximum lumen output.

**DEGREES**

Enables simple on-site adjustments of the luminaires to achieve precision, performance, and versatility. During installation, you can securely set the beam angle in 1-degree increments, with clear markings at every 5-degree interval.



# 3"

# EPD-3-SHAL-IC-ADJ

## Architectural LED Downlight- Shallow, IC Rated, Adjustable

## Edison Series

### Modifications Available

Consult factory for modification requests; orders may require shop drawing approval.

### Adjustable

Has full adjustable aiming capability, allowing the double gimbal mechanism to rotate 360°, pivot 90°, and lock into place at any desired position.

### Wall Wash

The optical assembly delivers uniform ceiling-to-floor wallwashing without creating any visible scallops. The optical assembly is specially designed to extend a beam in two directions for a uniform floor-to-ceiling and side-to-side wash of light.

### Housing / Mounting

- Intended for use in new construction projects and compatible with IC applications, this thermally protected, specification-grade adjustable recessed housing is designed for insulated ceilings where the housing will come into direct contact with insulation. Its die-formed, all-aluminum construction is coated in matte black for optimal heat dissipation, rust prevention, and glare-free illumination.
- The housing offers pre-installed bar hangers that offer flexibility in placement, allowing you to position and secure it within a 24" joist span. You have the option to position them along the long or short axis of the housing, and they can be shortened for 12" joists. If needed, these bar hangers can be adapted for T-Bar spline installation using additional slots and holes for special mounting methods. Additionally, the package includes butterfly brackets, constructed from sturdy 18-gauge steel, which can be vertically adjusted. These butterfly brackets are compatible with various mounting options, including 3/4" or 1-1/2" lathing channel, 1/2" EMT, and optional C-Channel mounting bars.

### Flange Option

Die-cast trim rings are powder coated after production and are offered in both white and customizable colors (For custom paint color choices, please contact our factory). The collar and trim rotate together, and all trims come standard with a Solite frosted lens (For more lens options, please get in touch with our factory). These trims are available in Open Downlight, Lensed Downlight, Pinhole Downlight, and Slot styles. Trims can be easily attached.

### Trim-less Option

This Die-Cast perforated mesh cover is designed for mounting in drywall or plaster ceilings. It allows for mudding right up to the luminaire opening, ensuring a seamless look. To prevent any damage to the ceiling or drywall during and after installation, a trimless accessory is fastened to the housing. The trims are connected to the housing using piano springs, ensuring a tight fit and eliminating any light leakage. These options are offered in Open Downlight, Lensed Downlight, Pinhole Downlight, and Slot configurations.

### Emergency Options/Controls

The test switch for the emergency battery can be installed on the side of the reflector (integral INTG-EMG option), or the test switch can be mounted remotely (EMG-LED option). Self Diagnostic emergency option available (EMG-SDT-LED-10W) Typical lumen output of the luminaire is up to 1000L with EMG-LED-10W or INTG-EMG-LED-10W option & 2000L with EMG-LED-20W or INTG-EMG-LED-20W option in emergency mode. Other accessories and controls systems include modular wiring systems, daylight harvesting controls, occupancy sensors, and/or power packs for individual or room control applications.

### Drivers

120/277V 50/60Hz; 347V available. THD < 20%; power factor >.09. Thermally protected. Removal of the reflector provides complete accessibility to the junction box, driver and internal components from above and below the ceiling through the aperture.

### Listings

- Thermally protected, IC rated up to 1500 lumens, not suitable for use with spray foam insulation
- c-UL-us - Listed for Feed Through Wiring.
- cULus Certified to UL 1598 / C22.2 suitable for Damp/Dry locations, indoor use only
- City of Chicago environmental air (CCEA) marking for plenum applications
- EMI/RFI emissions per FCC 47CFR Part 15 Class B
- RoHS - Contains no mercury or lead and RoHS compliant
- Photometric testing completed in accordance with IES LM-79, LM80 and TM-30 standards
- State of California Title 24 high efficacy LED compliance under JA8
- ENERGY STAR® certified with select trims and housings

### Tunable White Option

Tunable White allows the luminaires to be color tuned via various controls. Create the perfect environment for the desired use of the space or mimic the natural color patterns throughout the day and stimulate circadian rhythm. Available in tuning range of 50K-27K (TWH-50K-27K), 65K-27K (TWH-65K-27K), 65K-18K (TWH-LENGN-65K-18K).

### Dim to Warm Option

### RGB + White Option

Refine your space with Mood Master (RGBW & TW), which provides complete control over hue, color temperature, saturation, and dimming for design versatility. RGB + White technology has a white color tuning range from 6500K to 1650K. RGB color range derived from the primary colors red, green and blue is used to create infinite color options in the RGB palette, adding colors together in varying amounts to create new ones. RGB Tunable White technology enables users to adjust the color temperature, adding gradients of saturated colors. No longer restricted to white light LEDs, lighting designers and architects can manipulate a space with desired hues and shades, altering the color temperature of the room, creating the perfect environment. The use of RGB Tunable White technology in allows infinite possibilities for any application

### Xicato Artist Series LED Module (XIA)

Powered by Xicato Artist Series®, which are tested to IES TM-30-15, with a color fidelity score (Rf) of 96 and a color gamut score (Rg) of 102, and color shift less than du'v' of 0.003. Featuring cold phosphor technology, improving thermal management enhancing color consistency and delaying lumen depreciation.

### Natural Spectrum (NSL)

Natural Spectrum LED option is designed for Human Centric lighting application. Natural Spectrum LEDs diminish blue light peak, similar spectral curve to sunlight, accurate rendering of colors and reduced scattered reflection and glare.

### Dimming & Driver Information

**DIM10** - 0-10V dimming on either MVOLT 120, 277 or 347V. Dimmable down to 1% of initial lumens, standard

**LUTH** - Lutron LDE1 Hi-Lume Eco System with Soft Fade to Black 1% dimming

**LUTFTB** - Lutron PEQO Hi-Lume Premier Eco System LED Driver with soft-on fade to black 0.1% dimming

**ELDO10.1-LIN** - ELDO10-Linear with linear dimming curve.

**ELDODMX.1** - EldoLED PowerDrive dimming down to 0.1%. Please see EldoLED website for wiring diagrams and a list of compatible DMX and DALI control systems.

**ELDODALI.1** - EldoLED SoloDrive DALI-2. Dimming down to 0.1%

**DIMTR** - Triac & Electronic low voltage forward phase dimming. Available in 120V only

**BLE-CASAMBI** - Luminaires may be controlled, grouped, scheduled or placed in scenes , and or zones Via Cassambi Bluetooth 4.0 App.

**POE** - Power-over-Ethernet Depending on the PoE manufacturer selected

**DIM10-O-OFF** - Program DIM10-to OFF with linear dimming curve 0.1%



# 3"

# EPD-3-SHAL-IC-ADJ

Architectural LED Downlight- Shallow, IC Rated, Adjustable

## Edison Series

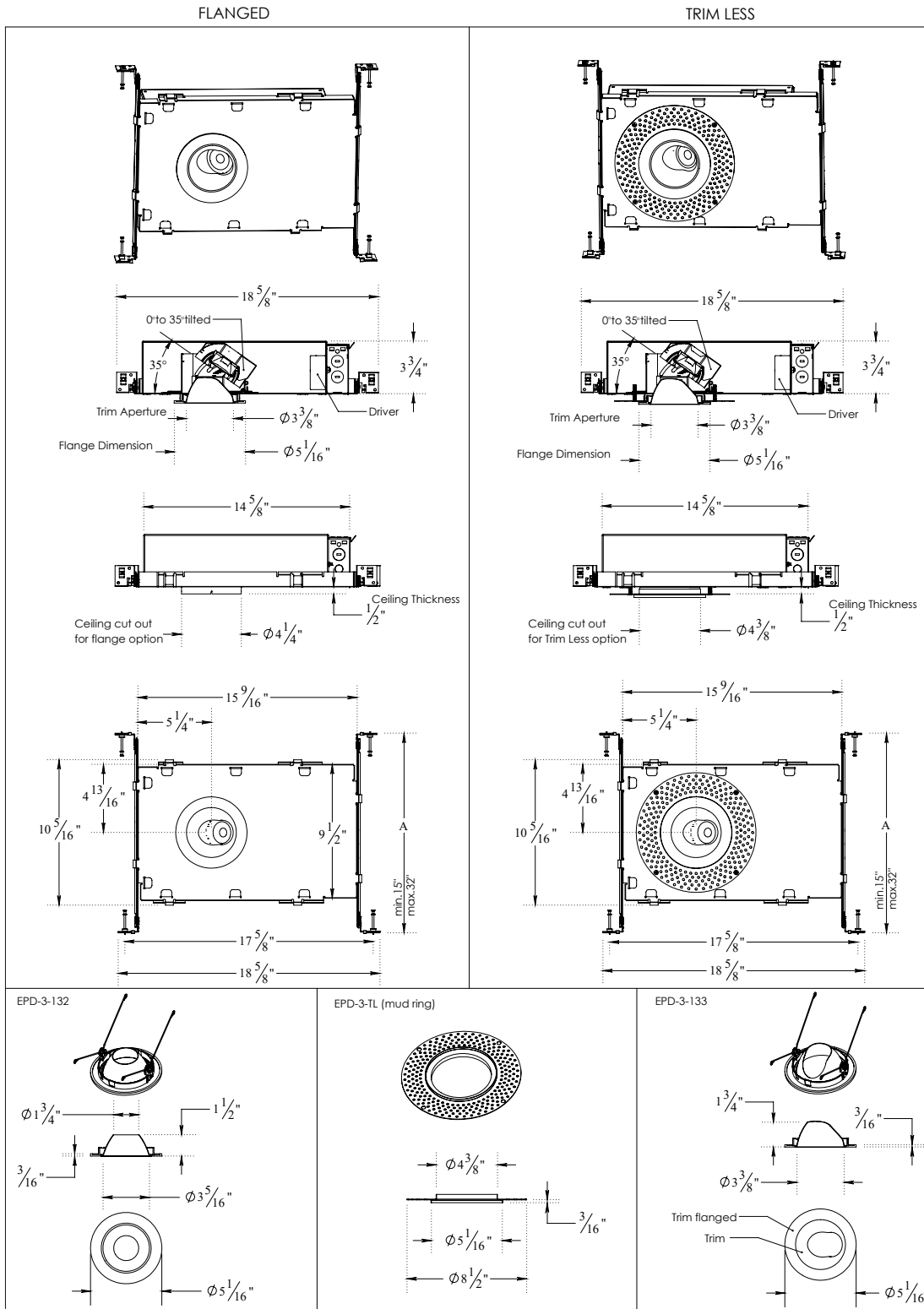

WWW.EPL.COM | 718.685.0700 | NEW YORK / LOS ANGELES

3"

Architectural LED Downlight- Shallow, IC Rated, Adjustable

EPD-3-SHAL-IC-ADJ

Edison Series

EPD-3-SHA L-IC-ADJ- 1200L-40K- 90-ND-DIM 10-MVO LT-EPD-3- 132

TESTNO:EPL121883

INPUTWATTS:16.2 LUMENS\$80 CRI90 EFFICAO% CCT#000K SPACINGCRITERIA0.54

Candle Power Distribution(Candelas)

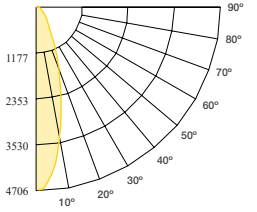

Zonal Lumens Summary

Table with 4 columns: Zone, Lumens, %Lamp, %Fixt. Rows include 0-20, 0-30, 0-40, 0-60, 0-80, 0-90.

Luminance (Average candela/M)

Table with 4 columns: Angle in Degrees, Average 0°, Average 45°, Average 90°. Rows include 45, 55, 65, 75, 85.

Lumens Per Zone

Table with 2 columns: Zone, Lumens. Rows include 0-10, 10-20, 20-30, 30-40, 40-50, 50-60, 60-70, 70-80, 80-90.

Candela Tabulation

Table with 2 columns: Candela Tabulation, Candela. Rows include 0, 5, 15, 25, 35, 45, 55, 65, 75, 85, 90.

Coefficients of Utilization- Zonal Cavity Method Effective Floor Cavity Reflectance 0.20

Large table with columns for RC, RW, and various reflectance percentages (70%, 80%, 10%, 50%, 30%, 10%, 0%). Rows include 0-10, 10-20, 20-30, 30-40, 40-50, 50-60, 60-70, 70-80, 80-90.

Cone of Light table with columns for beam diameter and height. Rows include 2, 4, 6, 8, 10, 12.

BEAMDIAM MEASUREMENT 50% OF NADIR @ C.

EPD-3-SHA L-IC-ADJ- 1200L-40K- 90-MD-DIM 10-MVO LT-EPD-3- 132

TESTNO:EPL121877

INPUTWATTS:6.4 LUMENS\$17 CRI90 EFFICAO% CCT#000K SPACINGCRITERIA0.68

Candle Power Distribution(Candelas)

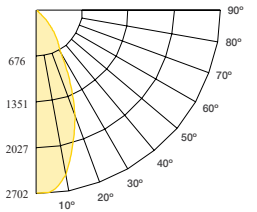

Zonal Lumens Summary

Table with 4 columns: Zone, Lumens, %Lamp, %Fixt. Rows include 0-20, 0-30, 0-40, 0-60, 0-80, 0-90.

Luminance (Average candela/M)

Table with 4 columns: Angle in Degrees, Average 0°, Average 45°, Average 90°. Rows include 45, 55, 65, 75, 85.

Lumens Per Zone

Table with 2 columns: Zone, Lumens. Rows include 0-10, 10-20, 20-30, 30-40, 40-50, 50-60, 60-70, 70-80, 80-90.

Candela Tabulation

Table with 2 columns: Candela Tabulation, Candela. Rows include 0, 5, 15, 25, 35, 45, 55, 65, 75, 85, 90.

Coefficients of Utilization- Zonal Cavity Method Effective Floor Cavity Reflectance 0.20

Large table with columns for RC, RW, and various reflectance percentages (70%, 80%, 10%, 50%, 30%, 10%, 0%). Rows include 0-10, 10-20, 20-30, 30-40, 40-50, 50-60, 60-70, 70-80, 80-90.

Cone of Light table with columns for beam diameter and height. Rows include 2, 4, 6, 8, 10, 12.

BEAMDIAM MEASUREMENT 50% OF NADIR @ C.

EPD-3-SHA L-IC-ADJ- 1200L-40K- 90-WD-DIM 10-MVO LT-EPD-3- 132

TESTNO:EPL121880

INPUTWATTS:16.4 LUMENS\$92 CRI90 EFFICAO% CCT#000K SPACINGCRITERIA0.78

Candle Power Distribution(Candelas)

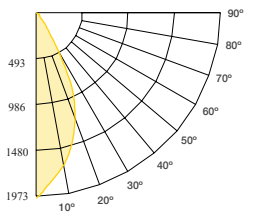

Zonal Lumens Summary

Table with 4 columns: Zone, Lumens, %Lamp, %Fixt. Rows include 0-20, 0-30, 0-40, 0-60, 0-80, 0-90.

Luminance (Average candela/M)

Table with 4 columns: Angle in Degrees, Average 0°, Average 45°, Average 90°. Rows include 45, 55, 65, 75, 85.

Lumens Per Zone

Table with 2 columns: Zone, Lumens. Rows include 0-10, 10-20, 20-30, 30-40, 40-50, 50-60, 60-70, 70-80, 80-90.

Candela Tabulation

Table with 2 columns: Candela Tabulation, Candela. Rows include 0, 5, 15, 25, 35, 45, 55, 65, 75, 85, 90.

Coefficients of Utilization- Zonal Cavity Method Effective Floor Cavity Reflectance 0.20

Large table with columns for RC, RW, and various reflectance percentages (70%, 80%, 10%, 50%, 30%, 10%, 0%). Rows include 0-10, 10-20, 20-30, 30-40, 40-50, 50-60, 60-70, 70-80, 80-90.

Cone of Light table with columns for beam diameter and height. Rows include 2, 4, 6, 8, 10, 12.

BEAMDIAM MEASUREMENT 50% OF NADIR @ C.





3"

Architectural LED Downlight- Shallow, IC Rated, Adjustable

EPD-3-SHAL-IC-ADJ

Edison Series

EPD-3-SHA L-IC-ADJ- 1200L-40K- 90-ND-DIM 10-MVO LT-EPD-3SQ- 132 TEST NO: EPL121884
INPUT WATTS:16.2 LUMENS:1368 CRI: 90 EFFICACY84 CCT:4000K SPACING CRITERIA: 0.54

Candle Power Distribution (Candelas)

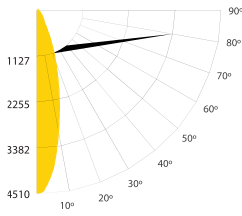

Zonal Lumens Summary

Table with 4 columns: Zone, Lumens, %Lamp, %Fixt. Rows include zones 0-20, 0-30, 0-40, 0-60, 0-80, 0-90.

Luminance (Average candela/m²)

Table with 4 columns: Angle in Degrees, Average 0°, Average 45°, Average 90°. Rows include zones 0-20 to 0-90.

Lumens Per Zone

Table with 2 columns: Zone, Lumens. Rows include zones 0-10 to 80-90.

Candela Tabulation

Table with 2 columns: Zone, Candela. Rows include zones 0 to 80-90.

Coefficients of Utilization - Zonal Cavity Method Effective Floor Cavity Reflectance 0.20

Large table with columns for RC, RW, and various reflectance percentages (70%, 50%, 30%, 10%, 0%). Rows include ROOM CAVITY RATIO from 0 to 10.

Cone of Light table with columns for beam diameter and candela values at different beam sizes (2, 4, 6, 8, 10, 12).

BEAM DIA. MEASURED AT 50% OF NADIR F.C.

EPD-3-SHA L-IC-ADJ- 1200L-40K- 90-MD-DIM 10-MVO LT-EPD-3SQ- 132 TEST NO: EPL121879
INPUT WATTS:16.4 LUMENS:1176 CRI: 90 EFFICACY72 CCT:4000K SPACING CRITERIA: 0.68

Candle Power Distribution (Candelas)

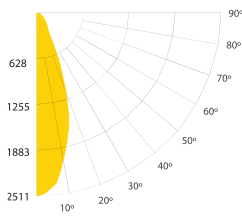

Zonal Lumens Summary

Table with 4 columns: Zone, Lumens, %Lamp, %Fixt. Rows include zones 0-20, 0-30, 0-40, 0-60, 0-80, 0-90.

Luminance (Average candela/m²)

Table with 4 columns: Angle in Degrees, Average 0°, Average 45°, Average 90°. Rows include zones 0-20 to 0-90.

Lumens Per Zone

Table with 2 columns: Zone, Lumens. Rows include zones 0-10 to 80-90.

Candela Tabulation

Table with 2 columns: Zone, Candela. Rows include zones 0 to 80-90.

Coefficients of Utilization - Zonal Cavity Method Effective Floor Cavity Reflectance 0.20

Large table with columns for RC, RW, and various reflectance percentages (70%, 50%, 30%, 10%, 0%). Rows include ROOM CAVITY RATIO from 0 to 10.

Cone of Light table with columns for beam diameter and candela values at different beam sizes (2, 4, 6, 8, 10, 12).

BEAM DIA. MEASURED AT 50% OF NADIR F.C.

EPD-3-SHA L-IC-ADJ- 1200L-40K- 90-WD-DIM 10-MVO LT-EPD-3SQ- 132 TEST NO: EPL121881
INPUT WATTS:16.2 LUMENS:1119 CRI: 90 EFFICACY69 CCT:4000K SPACING CRITERIA: 0.80

Candle Power Distribution (Candelas)

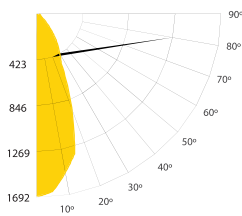

Zonal Lumens Summary

Table with 4 columns: Zone, Lumens, %Lamp, %Fixt. Rows include zones 0-20, 0-30, 0-40, 0-60, 0-80, 0-90.

Luminance (Average candela/m²)

Table with 4 columns: Angle in Degrees, Average 0°, Average 45°, Average 90°. Rows include zones 0-20 to 0-90.

Lumens Per Zone

Table with 2 columns: Zone, Lumens. Rows include zones 0-10 to 80-90.

Candela Tabulation

Table with 2 columns: Zone, Candela. Rows include zones 0 to 80-90.

Coefficients of Utilization - Zonal Cavity Method Effective Floor Cavity Reflectance 0.20

Large table with columns for RC, RW, and various reflectance percentages (70%, 50%, 30%, 10%, 0%). Rows include ROOM CAVITY RATIO from 0 to 10.

Cone of Light table with columns for beam diameter and candela values at different beam sizes (2, 4, 6, 8, 10, 12).

BEAM DIA. MEASURED AT 50% OF NADIR F.C.

