

4"

EPD-4-SHAL-IC

Architectural LED Downlight- Shallow, IC Rated

Edison Series



Application

This cutting-edge, high-efficiency round architectural downlight with a shallow plenum design is versatile and well-suited for a range of applications. It excels in environments requiring minimal housing depth, making it an ideal choice for

- Commercial elevator lobbies
- Hospitality settings
- Upscale residential areas
- Retail establishments

Features

- Cutting-edge, high-efficiency round architectural downlight
- Shallow plenum design, perfect for environments with minimal housing depth
- Maximizes functionality and provides gentle, anti-glare lighting
- Offers various distribution options and lumen packages

Nominal Lumens	Delivered Lumens	Wattage
900L	1019	10
1200L	1396	14
1500L	1450	18

Based on 4000K, 90+ CRI with semi-specular chrome reflector. Actual wattage may vary +/-5%

Lumens	High Performance: 900, 1200 Dims to Warm: 900, 1200, 1500 Xicato Artist: 900, 1200 Natural Spectrum: 900, 1200
CCT & Dynamic Platforms	High Performance: 27K, 30K, 35K, 40K, 50K Dims to Warm: 30K-18K, 30K-22K, 27K-18K Xicato Artist: 27K, 30K, 30K-VIB, 35K, 40K Natural Spectrum: 27K, 30K, 35K, 40K, 50K, 65K
CRI	High Performance: 90+, 98+ Dims to Warm: 90+ Xicato Artist: 98+ Natural Spectrum: 97+
Color Quality	2 Step MacAdam Ellipse
Distributions	SPD (Spot 15°), ND (Narrow 24°), MD (Medium 35°), MWD (Medium Wide 45°), WD (Wide 52°)
Trim Options	Downlight, Trim-less
Reflector Colors	W (White), RAL (Custom)
Flange Colors	WH (Self-Flanged White), RAL (Custom)
Dimming	DIM10, LUTH, LUTFTB, ELDO10.1, ELDODMX.1, ELDODALI.1, DIMTR, BLE-CASAMBI
Emergency	EMG-LED-10W[(Bodine BSL310)], EMG-LED-20W[(Bodine BSL20)], EMD-LED-G2-10W-SDT[Self Diagnostic (Consult Factory)]
Lifetime	L70 at 102,000 Hours
Photometric Tests	In Accordance with IES LM79-08, LM80 and TM-30, TM-21



4"

EPD-4-SHAL-IC

Architectural LED Downlight- Shallow, IC Rated

Edison Series

PART NUMBER: **EPD-4-SHAL-IC-900L-27K-90-SPD-DIM10-120V**

Series	Lumens	CCT	CRI	Optics	Driver	Voltage	Emergency	Options
EPD-4-SHAL-IC	900L 1200L	27K 30K 35K 40K 50K¹	90+ 98+²	SPD Spot (15°) ND Narrow (24°) MD Medium (35°) MWD Medium Wide (45°) WD Wide (52°)	DIM10 LUTH LUTFTB⁴ ELDO10.1 ELDODMX.1 ELDODALI.1 DIMTR³ BLE-CASAMBI	120V 277V MVOLT 347V⁵	- EMG-LED-10W <small>(Bodine BSL310)</small> EMG-LED-20W <small>(Bodine BSL20)</small> EMD-LED-G2-10W-SDT <small>Self Diagnostic (Consult Factory)</small>	- CP⁶ USA

¹ 50K series are available with 85+ CRI only ² 98+ CRI is available in 27K, 30K and 40K only ³ DIMTR available in 120V only ⁴ LUTFTB Available for luminaires up to 1500L ⁵ 347V is available in only DIM10 ⁶ CP Available for luminaires up to 1500L

PART NUMBER: **EPD-4-SHAL-IC-WDM-30K-18K-900L-90-SPD-DIM10-120V**

Series	Technology	Lumens	CRI	Optics	Driver	Voltage	Emergency	Options
EPD-4-SHAL-IC-WDM <small>(Dim to Warm)</small>	30K-18K 30K-22K 27K-18K	900L 1200L 1500L	90+	SPD Spot (15°) ND Narrow (24°) MD Medium (35°) MWD Medium Wide (45°) WD Wide (52°)	DIM10 LUTH LUTFTB² DIMTR¹ ELDO10.1 ELDODALI.1 ELDODMX.1 BLE-CASAMBI	120V 277V MVOLT 347V⁴	- EMG-LED-10W <small>(Bodine BSL310)</small> EMG-LED-20W <small>(Bodine BSL20)</small> EMD-LED-G2-10W-SDT <small>Self Diagnostic (Consult Factory)</small>	- CP³ USA

¹ DIMTR available in 120V only ² LUTFTB Available for luminaires up to 1500L ³ CP Available for luminaires up to 1500L ⁴ 347V is available in only DIM10

4"

EPD-4-SHAL-IC

Architectural LED Downlight- Shallow, IC Rated

Edison Series

PART NUMBER: **EPD-4-SHAL-IC-XIA-900L-27K-98-SPD-DIM10-120V**

Series	Lumens	CCT	CRI	Optics	Driver	Voltage	Emergency	Options
EPD-4-SHAL-IC-XIA <i>(Xicato Artist)</i>	900L 1200L	27K 30K 30K-VIB 35K 40K	98+	SPD Spot (15°) ND Narrow (24°) MD Medium (35°) MWD Medium Wide (45°) WD Wide (52°)	DIM10 LUTH LUTFTB² ELDO10.1 ELDODMX.1 ELDODALI.1 DIMTR¹ BLE-CASAMBI	120V 277V MVOLT 347V³	- EMG-LED-10W <small>(Bodine BSL310)</small> EMG-LED-20W <small>(Bodine BSL20)</small> EMD-LED-G2-10W-SDT <small>Self Diagnostic (Consult Factory)</small>	- CP⁴ USA

1 DIMTR available in 120V only **2** LUTFTB Available for luminaires up to 1500L **3** 347V is available in only DIM10 **4** CP Available for luminaires up to 1500L

PART NUMBER: **EPD-4-SHAL-IC-NSL-900L-27K-97-SPD-DIM10-120V**

Series	Lumens	CCT	CRI	Optics	Driver	Voltage	Emergency	Options
EPD-4-SHAL-IC-NSL <i>(Natural Spectrum)</i>	900L 1200L	27K 30K 35K 40K 50K 65K	97+	SPD Spot (15°) ND Narrow (24°) MD Medium (35°) MWD Medium Wide (45°) WD Wide (52°)	DIM10 LUTH LUTFTB² ELDO10.1 ELDODMX.1 ELDODALI.1 DIMTR¹ BLE-CASAMBI	120V 277V MVOLT 347V³	- EMG-LED-10W <small>(Bodine BSL310)</small> EMG-LED-20W <small>(Bodine BSL20)</small> EMD-LED-G2-10W-SDT <small>Self Diagnostic (Consult Factory)</small>	- CP⁴ USA

1 DIMTR available in 120V only **2** LUTFTB Available for luminaires up to 1500L **3** 347V is available in only DIM10 **4** CP Available for luminaires up to 1500L









4"

Architectural LED Downlight- Shallow, IC Rated

EPD-4-SHAL-IC

Edison Series

ORDERING GUIDE:

REFLECTOR TYPE	MOUNTING	FINISH
 EPD-4-142 Open Downlight	 Round Flanged	 WH-WH White  RAL Custom Color
 EPD-4-TL-142 Open Downlight	 Round Trimless	 WH White  BK Black

4"

Architectural LED Downlight- Shallow, IC Rated

EPD-4-SHAL-IC

Edison Series

Modifications Available

Consult factory for modification requests; orders may require shop drawing approval.

Housing / Mounting

16-gauge steel, preassembled one-piece construction with integral 27" C-channel mounting brackets included. Mounting brackets may be adjusted up to 28" horizontally, and 2-3/4" vertically, and locking into place.

Emergency Options/Controls

The test switch for the emergency battery can be installed on the side of the reflector (integral INTG-EMG option), or the test switch can be mounted remotely (EMG-LED option). Self Diagnostic emergency option available (EMG-SDT-LED-10W) Typical lumen output of the luminaire is up to 1000L with EMG-LED-10W or INTG-EMG-LED-10W option & 2000L with EMG-LED-20W or INTG-EMG-LED-20W option in emergency mode. Other accessories and controls systems include modular wiring systems, daylight harvesting controls, occupancy sensors, and/or power packs for individual or room control applications.

Drivers

120/277V 50/60Hz; 347V available. THD < 20%; power factor >.09. Thermally protected. Removal of the reflector provides complete accessibility to the junction box, driver and internal components from above and below the ceiling through the aperture.

Driver Electrical Information

The LED driver operates within the range of 50 to 60Hz at 120V/277V, with an additional option for 347V input. It generates less than 20% total harmonic distortion (THD) and maintains a power factor between 90% and 100%. The driver is equipped with thermal protection for enhanced safety. Both the junction box and driver can be accessed from both below and above the ceiling. The junction box is certified for through-branch circuit wiring.

Listings

- c-UL-us - Listed for Feed Through Wiring.
- c-UL-us - Listed for Damp Location.
- All LED luminaires are rated and tested to LM-79 and LM-80 standards by an independent laboratory. Energy Star, JA8 and California Title 24 compliant.

Dim to Warm Option

Dims to Warm simulates traditional incandescent halogen lighting through dimming. When the luminaire dims to warm from 100% to .1%, it makes a smooth transition across the black body radiator while maintaining a constant CRI of 90+. Available in 30K-18K, 30K-22K or 27K-18K range.

Dimming & Driver Information

DIM10 - 0-10V dimming on either MVOLT 120, 277 or 347V. Dimmable down to 1% of initial lumens, standard

LUTH - Lutron LDE1 Hi-Lume Eco System with Soft Fade to Black 1% dimming

LUTFTB - Lutron PEQO Hi-Lume Premier Eco System LED Driver with soft-on fade to black 0.1% dimming

ELDO10.1 - EldoLED SoloDrive 0-10V. Dimming down to 0.1%

ELDODMX.1 - EldoLED PowerDrive dimming down to 0.1%. Please see EldoLED website for wiring diagrams and a list of compatible DMX and DALI control systems.

ELDODALI.1 - EldoLED SoloDrive DALI-2. Dimming down to 0.1%

DIMTR - Triac & Electronic low voltage forwardp hase dimming. Available in 120V only

BLE-CASAMBI - Luminaires may be controlled, grouped, scheduled or placed in scenes , and or zones Via Cassambi Bluetooth 4.0 App.



4"

EPD-4-SHAL-IC

Architectural LED Downlight- Shallow, IC Rated

Edison Series

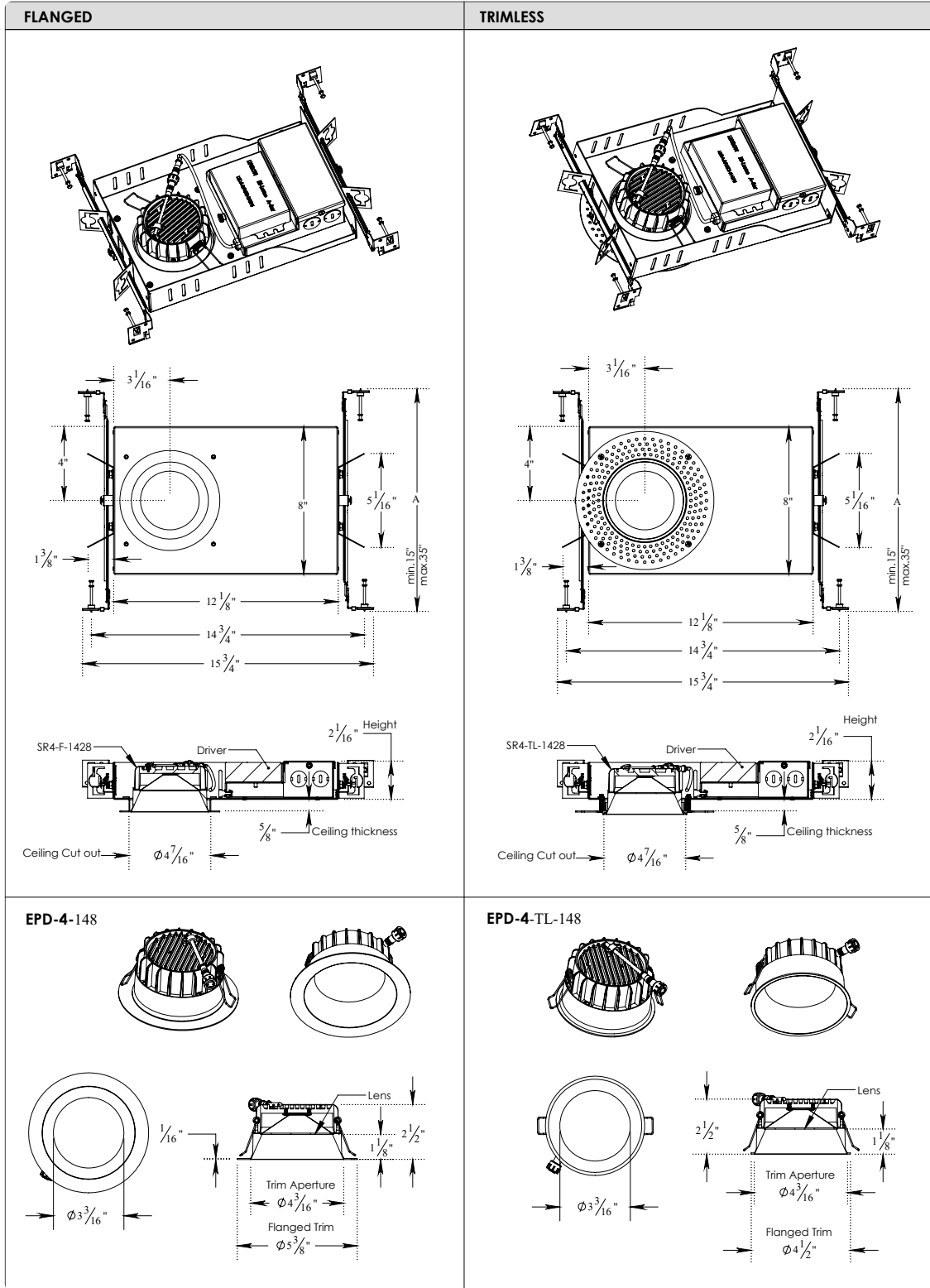

4"

EPD-4-SHAL-IC

Architectural LED Downlight- Shallow, IC Rated

Edison Series

EPD-4-SHAL-IC-1200L-40K-90-WD-DIM10-120V-EPD-4-142-WH-WH

TEST NO.: EL04132322

INPUT WATTS: 10.1

LUMENS: 1146

EFFICACY: 113

BEAM ANGLE: 60

SPACING CRITERIA: 0.88

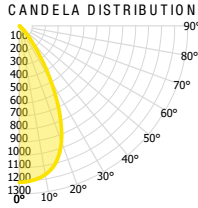

CANDELA TABLE

	0°	90°
0°	1210	1213
10°	1167	1198
20°	954	1053
30°	486	629
40°	133	191
50°	24	48
60°	9	12
70°	4	4
80°	2	2
90°	0	0

LUMINANCE (cd/sq.m)

	0.00°	90.00°
0.00°	103681	103879
45.00°	7378	11985
55.00°	2003	2607
65.00°	1048	1226
75.00°	1009	1162
85.00°	256	816

LUMENS PER ZONE

ZONE	LUMENS
0° - 10°	121
10° - 20°	316
20° - 30°	375
30° - 40°	224
40° - 50°	77
50° - 60°	20
60° - 70°	7
70° - 80°	3
80° - 90°	1

ZONAL LUMEN SUMMARY

ZONE	UMENS	% LUMINAIRE
0° - 20°	438	38%
0° - 30°	813	71%
0° - 40°	1037	91%
0° - 60°	1134	99%
0° - 80°	1144	100%
0° - 90°	1145	100%

CONE OF LIGHT

MOUNTING HEIGHT	FC AT BEAM CENTER	BEAM DIA. 0°-180°	BEAM DIA. 90°-270°
6.0 ft	33.6 fc	6.9 ft	6.9 ft
8.0 ft	18.9 fc	9.2 ft	9.2 ft
10.0 ft	12.1 fc	11.5 ft	11.5 ft
12.0 ft	8.4 fc	13.8 ft	13.8 ft
14.0 ft	6.2 fc	16.1 ft	16.0 ft
16.0 ft	4.7 fc	18.4 ft	18.3 ft
18.0 ft	3.7 fc	20.7 ft	20.6 ft
20.0 ft	3.0 fc	22.9 ft	22.9 ft

INDOOR COEFFICIENTS OF UTILIZATION

ρf	80%										70%										20%										0%
	ρw	70%	50%	30%	10%	70%	50%	30%	10%	50%	30%	10%	50%	30%	10%	50%	30%	10%	50%	30%	10%	0%									
0	119	119	119	119	119	117	117	117	111	111	111	111	107	107	107	107	107	102	102	102	102	100									
1	114	111	108	106	111	109	106	104	105	103	101	99	98	97	96	95	93	93	93	93	93	93									
2	108	103	99	95	106	101	98	94	98	95	92	95	92	90	92	90	88	87	87	87	87	87									
3	102	96	91	87	100	94	90	86	92	88	85	89	86	83	87	84	82	81	81	81	81	81									
4	97	90	84	80	95	88	83	79	86	82	78	84	80	77	82	79	76	75	75	75	75										
5	92	84	78	73	91	83	77	73	81	76	72	79	75	72	78	74	71	70	70	70	70										
6	88	79	73	68	86	78	72	68	76	71	67	75	70	67	73	70	67	65	65	65	65										
7	83	74	68	64	82	73	67	63	72	67	63	71	66	63	70	65	62	61	61	61	61										
8	79	70	64	59	78	69	63	59	68	63	59	67	62	59	66	62	58	57	57	57	57										
9	75	66	60	56	74	65	59	56	64	59	55	63	59	55	62	58	55	54	54	54	54										
10	72	62	56	52	71	62	56	52	61	56	52	60	55	52	59	55	52	51	51	51	51										

EPD-4-SHAL-IC-1200L-40K-90-VWD-DIM10-120V-EPD-4-142-WH-WH

TEST NO.: EL053122154

INPUT WATTS: 10.1

LUMENS: 1233

EFFICACY: 122

BEAM ANGLE: 98

SPACING CRITERIA: 1.18 x 1.18

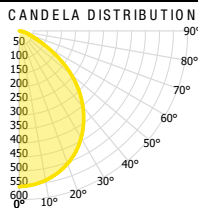

CANDELA TABLE

	0°	90°
0°	556	556
10°	542	540
20°	504	501
30°	442	440
40°	354	355
50°	243	251
60°	116	127
70°	38	43
80°	14	17
90°	0	0

LUMINANCE (cd/sq.m)

	0.00°	90.00°
0.00°	47622	47622
45.00°	36496	37025
55.00°	26754	28410
65.00°	13312	15175
75.00°	8423	9227
85.00°	4373	6939

LUMENS PER ZONE

ZONE	LUMENS
0° - 10°	53
10° - 20°	150
20° - 30°	223
30° - 40°	258
40° - 50°	246
50° - 60°	180
60° - 70°	84
70° - 80°	31
80° - 90°	8

ZONAL LUMEN SUMMARY

ZONE	UMENS	% LUMINAIRE
0° - 20°	202	16%
0° - 30°	425	34%
0° - 40°	684	55%
0° - 60°	1109	90%
0° - 80°	1224	99%
0° - 90°	1233	100%

CONE OF LIGHT

MOUNTING HEIGHT	FC AT BEAM CENTER	BEAM DIA. 0°-180°	BEAM DIA. 90°-270°
6.0 ft	15.4 fc	13.7 ft	13.7 ft
8.0 ft	8.7 fc	18.3 ft	18.3 ft
10.0 ft	5.6 fc	22.9 ft	22.9 ft
12.0 ft	3.9 fc	27.4 ft	27.5 ft
14.0 ft	2.8 fc	32.0 ft	32.0 ft
16.0 ft	2.2 fc	36.6 ft	36.6 ft
18.0 ft	1.7 fc	41.1 ft	41.2 ft
20.0 ft	1.4 fc	45.7 ft	45.8 ft

INDOOR COEFFICIENTS OF UTILIZATION

ρf	80%										70%										20%										0%
	ρw	70%	50%	30%	10%	70%	50%	30%	10%	50%	30%	10%	50%	30%	10%	50%	30%	10%	50%	30%	10%	0%									
0	119	119	119	119	116	116	116	116	111	111	111	106	106	106	102	102	102	100	100	100	100	100									
1	111	107	103	100	108	104	101	98	100	98	95	96	94	92	93	91	90	88	88	88	88	88									
2	102	95	89	84	100	93	88	83	90	85	81	86	83	79	84	80	78	76	76	76	76	76									
3	94	85	78	72	92	83	77	71	80	75	70	78	73	69	75	71	68	66	66	66	66	66									
4	87	76	68	62	85	75	67	62	72	66	61	70	65	60	68	63	59	57	57	57	57	57									
5	80	69	60	54	78	67	60	54	65	59	54	64	58	53	62	57	52	50	50	50	50	50									
6	74	62	54	48	73	61	53	48	60	53	47	58	52	47	56	51	47	45	45	45	45	45									
7	69	57	49	43	68	56	48	43	54	47	42	53	47	42	52	46	42	40	40	40	40	40									
8	65	52	44	38	63	51	44	38	50	43	38	49	43	38	48	42	38	36	36	36	36	36									
9	60	48	40	35	59	47	40	35	46	39	35	45	39	34	44	38	34	33	33	33	33	33									
10	57	44	37	32	56	44	37	32	43	36	32	42	36	31	41	35	31	30	30	30	30	30									

