

6"

Architectural LED Downlight - IC Rated

EPD-6IC-RGBW

Edison Series

PART NUMBER: **EPD-6IC-TWH-50K-27K-900L-90-NSPD-DIM10-120V**









Series	Technology	Lumens	CRI	Optics	Drivers	Voltage	Emergency	Options	Accessories
EPD-6IC <i>(Tunable White)</i>	TWH-50K-27K	900L	90+	NSPD	DIM10 1	120V	-	-	-
	TWH-65K-27K	1200L		SPD	ELDODALI.1	277V	EMG-LED-10W	USA	EC-WC-TWH-HW-MVOLT
		1500L		ND	ELDODMX.1	MVOLT	EMG-LED-20W		
		2000L		MD	LUT-PSQ02U 2		INTG-EMG-LED-10W		
				MWD	BLE-CASAMBI		INTG-EMG-LED-20W		
				WD			EMG-SDT-LED-10W		
				VWD					

1 For DIM10 driver you must dedicate two control inputs, one for the Dimming Control and another for CCT Tuning 2 Lutron is the T-Series 2-Channel Tunable White EcoSystem

PART NUMBER: **EPD-6IC-RGBW-LENGN-65K-18K-1100L-90-NSPD-ELDODMX.1-120V**

Series	Technology	Lumens	CRI	Optics	Drivers	Voltage	Emergency	Options
EPD-6IC <i>(RGB + White)</i>	RGBW-LENGN-65K-18K	1100L	90+	NSPD	ELDODMX.1	120V	-	-
				SPD		277V	PELI-S-20	USA
				ND		MVOLT	PELI-S-100	
				MD			PELI-S-250	
				MWD			PELI-S-400	
				WD				
				VWD				

ORDER GUIDE

REFLECTOR TYPE				MOUNTING	COLOR				
REFLECTOR TYPE				MOUNTING	COLOR				
Open Downlight EPD-6-601	Wall Wash EPD-6-607	Double Wall Wash EPD-6-677	Corner Wall Wash ?	Flanged 	ANODIZED FLANGED				
					Clear White CL-WH	Clear Bronze CL-BZ	Black White BK-WH	Satin Haze SHZ-SHZ	Wheat WT-WT
					Clear Semi-Spec CL-SCH	Satin Haze White SHZ-WH	Black BK-BK	Satin Haze Black SHZ-BK	
					Clear Black CL-BK	White WH-WH	Bronze BZ-BZ	Wheat White WT-WH	
Open Downlight EPD-6-TL-601	Wall Wash EPD-6-TL-607			Trimless 	ANODIZED TRIMLESS				
					White WH	Black BK	Clear CL	Satin Haze SHZ	

6"

Architectural LED Downlight - IC Rated

EPD-6IC-RGBW

Edison Series

Modifications Available

Consult factory for modification requests; orders may require shop drawing approval.

Downlight

Our signature anodized reflector, spun to a reverse parabola design, achieves a 50° shielding angle and a 40° cut-off, which eliminates inter-reflections, and enhances low aperture brightness

Optical Performance and Trim

Spun aluminum anodized single piece reflector. The optical system consists of 1) an upper reflector for a precise beam spread; 2) a solite soft focus lens to diffuse the light source for smooth, striation-free distribution; 3) and a patented lens to control the beam angle and provide a 40° visual cutoff. Available in a variety of beam angles. Integral heatsink comes preinstalled on the housing for maximum heat dissipation and locks together with the reflector to prevent zero light leakage for above the ceiling.

Fully Servicable - Easy Installation & Upgrading

Housing maybe installed in ceilings of up to 1-1/2 inch thickness without the use of additional collars. Torsion springs on each side of the reflector hold snug to the ceiling, and allows for fast, easy installation into housing, and fast removal for easy access to the junction box from below the ceiling.

Trim Design

Luminaire is designed for installation in sheetrock or T-Bar ceilings to achieve a flush trim detail.

- Trimless option has a perforated face. Installation includes the application of drywall compound over the luminaire's integral spackle screen to the rim of its integral plaster ring.

Housing / Mounting

16-gauge steel, preassembled one-piece construction with integral 27" C-channel mounting brackets included. Mounting brackets may be adjusted up to 28" horizontally, and 2-3/4" vertically, and locking into place.

Emergency Options/Controls

The test switch for the emergency battery can be installed on the side of the reflector (integral INTG-EMG option), or the test switch can be mounted remotely (EMG-LED option). Self Diagnostic emergency option available (EMG-SDT-LED-10W) Typical lumen output of the luminaire is up to 1000L with EMG-LED-10W or INTG-EMG-LED-10W option & 2000L with EMG-LED-20W or INTG-EMG-LED-20W option in emergency mode. Other accessories and controls systems include modular wiring systems, daylight harvesting controls, occupancy sensors, and/or power packs for individual or room control applications.

Driver

RGB+White platform with tuning range of 6500K to 1650K, Saturation and Hue Gradients of color can be added in increments of 1% to fully saturated colors at 100% enabling gamut access to pastels and saturated colors (RGBW- 65K-16K). Control via, DMX-512/RDM.

Tunable White Option

Tunable White allows the luminaires to be color tuned via various controls. Create the perfect environment for the desired use of the space or mimic the natural color patterns throughout the day and stimulate circadian rhythm. Available in tuning range of 50K-27K (TWH-50K-27K), 65K-27K (TWH-65K-27K), 65K-18K (TWH-LENGN-65K-18K), or Lumenetix Araya 5 platform 80K-16K (TWH-LTX-80K-16K).

RGB + White Option

Refine your space with Mood Master (RGBW & TW), which provides complete control over hue, color temperature, saturation, and dimming for design versatility. RGB + White technology has a white color tuning range from 6500K to 1650K. RGB color range derived from the primary colors red, green and blue is used to create infinite color options in the RGB palette, adding colors together in varying amounts to create new ones. RGB Tunable White technology enables users to adjust the color temperature, adding gradients of saturated colors. No longer restricted to white light LEDs, lighting designers and architects can manipulate a space with desired hues and shades, altering the color temperature of the room, creating the perfect environment. The use of RGB Tunable White technology in allows infinite possibilities for any application

Dimming & Driver Information

DIM10 - 0-10V dimming on either MVOLT 120, 277 or 347V. Dimmable down to 1% of initial lumens, standard

ELDODALI.1 - EldoLED SoloDrive DALI-2. Dimming down to 0.1%

ELDODMX.1 - EldoLED PowerDrive dimming down to 0.1%. Please see EldoLED website for wiring diagrams and a list of compatible DMX and DALI control systems.

LUT-PSQ02U - Lutron dual channel T-Series LED Drivers

BLE-CASAMBI - Luminaires may be controlled, grouped, scheduled or placed in scenes, and or zones Via Cassambi Bluetooth 4.0 App."



6"

Architectural LED Downlight - IC Rated

EPD-6IC-RGBW

Edison Series

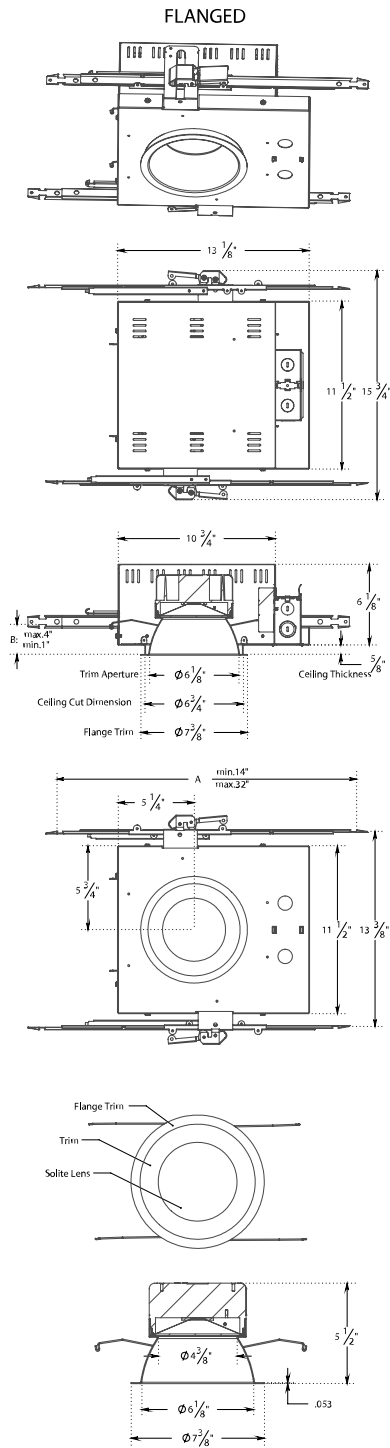

WWW.EPL.COM | 718.685.0700 | NEW YORK / LOS ANGELES