

3"

3" Suspended Mount Architectural Cylinders

BOLD-3-CYL-ADJ-SM



Bold Cylinders Series



APPLICATION & FEATURES

BOLD-3-CYL-ADJ-SM A small-profile architectural LED cylinder pendant luminaire featuring a modern die-cast design with a 3" round or square aperture. Offered in open, lensed downlight, and wallwash trim options, it delivers glare-free, high-quality illumination for general lighting needs. With a broad range of color temperatures supporting cool to warm tones, it integrates into any design and is well suited for commercial, retail, hospitality, and high-end residential applications.

This cylinder provides exceptional optical quality (up to 98 CRI, 1x2 Step MacAdam Ellipse) and supports multiple dimming protocols down to 0.1%. It offers a selection of compatible lens filters and accessories, and includes mounting options such as flush mount, surface mount, suspended, and pendant mount. The modular heatsink and power supply are removable and upgradeable. Available in standard 15-inch and shallow 12-inch heights.

LUMENS	High Performance: 900L, 1200L, 1500L and 2000L Warm Dimming: 900L, 1200L, 1500L and 2000L Xicato Artist: 900L, 1200L and 1500L
CCT & DYNAMIC PLATFORMS	High Performance: 27K, 30K, 35K, 40K and 50K Warm Dimming: 18K-30K Xicato Artist: 27K, 30K, 30K-VIB, 35K and 40K
CRI	High Performance: 90+ and 98+ Warm Dimming: 90+ Xicato Artist: 90+ and 98+
COLOR QUALITY	2 Step MacAdam Ellipse
DISTRIBUTIONS	Very Narrow Spot (10°), Narrow Spot (15°), Spot (24°), Medium (36°) and Wide (60°)
DRIVERS	High Performance: DIM10, LUTH, LUTFTB, ELDO10.1-LIN, ELDODMX.1, ELDODALI.1, DIMTR, BLE-CASAMBI, POE, DIM10-0-OFF, ELDO10-LOG, XSR and DIM10-AUX Warm Dimming: DIM10, LUTH, LUTFTB, ELDO10.1-LIN, ELDODMX.1, ELDODALI.1, DIMTR, BLE-CASAMBI, POE, DIM10-0-OFF, ELDO10-LOG, XSR and DIM10-AUX Xicato Artist: DIM10, LUTH, LUTFTB, ELDO10.1-LIN, ELDODMX.1, ELDODALI.1, DIMTR, BLE-CASAMBI, POE, DIM10-0-OFF, ELDO10-LOG, XSR and DIM10-AUX
TRIM OPTIONS	Adjustable: Trimless
FINISH OPTIONS	Anodized: Chrome (CL), Satin Haze (SHZ) Diecast: White (WH), Black (BK), Custom Color (RAL)
EMERGENCY	EMG-10, EMG-20, EMG-10-SDT, EMG-20-SDT and GTD
LIFETIME	LED is rated for >60,000 hours at 70% lumen maintenance
PHOTOMETRIC TESTS	In Accordance with IES LM79-08, LM80 and TM-30, TM-21
LISTINGS	 

3"

BOLD-3-CYL-ADJ-SM

3" Suspended Mount Architectural Cylinders

Bold Cylinders Series

High Performance: BOLD-3-CYL-ADJ-SM-12-WH-900L-27K-90-10D-DIM10-120V

Series	Mounting Lengths	Finish	Lumens	CCT	CRI	Optics	Driver	Voltage	Emergency	Options	Optical Accessories
BOLD-3-CYL-ADJ-SM	12	WH	900L	27K	90+	10D	DIM10	120V	-	-	-
	12 inches	White	1200L	30K	98+ 2	Very Narrow Spot (10°)	LUTH	MVOLT	All emergency options require top access, remote emergency test switch included	RIF RIF Filter	SOFL Solite Frosted
	18	BK	1500L	35K		15D	LUTFTB	347V 4		REM 5 Single Remote Dimming Driver	
	18 inches	Black	2000L	40K		Narrow Spot (15°)	ELDO10.1-LIN			BABA Made in America Compliance	
	24	RAL		50K		24D	ELDODMX.1			EMG-10	Controls See last page
	24 inches	Custom Color				Spot (24°)	ELDODALI.1			EMG-20	
36					36D	DIMTR 3			EMG-10-SDT		
36 inches					Medium (36°)	BLE-CASAMBI			EMG-20-SDT		
48					60D	DIM10-0-OFF			EMG-20-SDT		
48 inches					Wide (60°)	ELDO10-LOG			GTD		
						XSR					
						DIM10-AUX					

Any fixture can take maximum 2 Optical Accessories **1** The highest lumen will not be compatible with any optical accessories **2** 98+ CRI is available only on 27K, 30K and 40K **3** DIMTR is only available with 120V **4** 347V is only available with DIM10 **5** Remote mount Maximum distance from light fixture to remote power supply is 100' using 14 gauge wire, 50' using 16 gauge wire

Warm Dimming: BOLD-3-CYL-ADJ-SM-WDM-12-WH-900L-18K-30K-90-10D-DIM10-120V

Series	Mounting Lengths	Finish	Lumens	CCT	CRI	Optics	Driver	Voltage	Emergency	Options	Optical Accessories
BOLD-3-CYL-ADJ-SM-WDM	12	WH	900L	18K-	90+	10D	DIM10	120V	-	-	-
	12 inches	White	1200L	30K		Very Narrow Spot (10°)	LUTH	MVOLT	All emergency options require top access, remote emergency test switch included	RIF RIF Filter	SOFL Solite Frosted
	18	BK	1500L			15D	LUTFTB	347V 3		REM 4 Single Remote Dimming Driver	
	18 inches	Black	2000L 1			Narrow Spot (15°)	ELDO10.1-LIN			BABA Made in America Compliance	
	24	RAL				24D	ELDODMX.1			EMG-10	
	24 inches	Custom Color				Spot (24°)	ELDODALI.1			EMG-20	
36					36D	DIMTR 2			EMG-10-SDT		
36 inches					Medium (36°)	BLE-CASAMBI			EMG-20-SDT		
48					60D	DIM10-0-OFF			EMG-20-SDT		
48 inches					Wide (60°)	ELDO10-LOG			GTD		
						XSR					
						DIM10-AUX					

Any fixture can take maximum 2 Optical Accessories **1** The highest lumen will not be compatible with any optical accessories **2** DIMTR is only available with 120V **3** 347V is only available with DIM10 **4** Remote mount Maximum distance from light fixture to remote power supply is 100' using 14 gauge wire, 50' using 16 gauge wire

3"

BOLD-3-CYL-ADJ-SM

3" Suspended Mount Architectural Cylinders

Bold Cylinders Series

Xicato Artist: **BOLD-3-CYL-ADJ-SM-XIA-12-WH-900L-27K-90-10D-DIM10-120V**

Series	Mounting Lengths	Finish	Lumens	CCT	CRI	Optics	Driver	Voltage	Emergency	Options	Optical Accessories
BOLD-3-CYL-ADJ-SM-XIA	12	WH	900L	27K	90+	10D	DIM10	120V	-	-	-
	12 inches	White	1200L	30K	98+ 2	Very Narrow Spot (10°)	LUTH	MVOLT	All emergency options require top access, remote emergency test switch included	RIF	SOFL
	18	BK	1500L 1	30K-			LUTFTB	347V 4		RIF Filter	Solite Frosted
	18 inches	Black		VIB		15D	ELDO10.1-LIN			REM 5	
	24	RAL		35K		Narrow Spot (15°)	ELDODMX.1			Single Remote Dimming Driver	
24 inches	Custom Color		40K		Spot (24°)	ELDODALI.1			BABA		
36					Medium (36°)	DIMTR 3	BLE-CASAMBI		EMG-10	Made in America Compliance	
36 inches							POE		EMG-20		
48							DIM10-0-OFF		EMG-10-SDT		
48 inches							ELDO10-LOG		EMG-20-SDT		
							XSR		GTD		
							DIM10-AUX				

Any fixture can take maximum 2 Optical Accessories **1** The highest lumen will not be compatible with any optical accessories **2** 95+ CRI is not available on 50K **3** DIMTR is only available with 120V **4** 347V is only available with DIM10 **5** Remote mount Maximum distance from light fixture to remote power supply is 100' using 14 gauge wire, 50' using 16 gauge wire

3"



3" Suspended Mount Architectural Cylinders

BOLD-3-CYL-ADJ-SM

Bold Cylinders Series

TRIMLESS/MILLWORK REFLECTOR TYPE

Example: **B3R-363-TL-A-TL-WH**

Trim Option		Trim Construction	Trim Flange Opt.	Reflector Finishes
		A Anodized DC Diecast	TL Trimless MW 1 Millwork DMW 2 Diecast Millwork	WH White BK Black CL 1 Chrome SHZ 1 Satin Haze RAL Custom Color (Consult Factory)

Note: All extra optical accessories, aperture assemblies, and optics can be ordered separately. Check our website for ordering nomenclature.

DESCRIPTION

The BOLD-3-CYL-ADJ-SM A compact architectural LED cylinder available in 3" round or square apertures, offered with open, lensed, or wallwash trim options. Designed for glare-free general illumination with a modern die-cast aesthetic, it integrates seamlessly into commercial, retail, hospitality, and high-end residential spaces.

ADJUSTABILITY

Adjustable Accent delivers 365° tool-free rotation and precision-controlled 30° tilt. Tilt is adjustable in 1° increments with clearly marked internal degree indicators for accurate, repeatable aiming.

CONSTRUCTION

Round and square extruded aluminum cylinders with a post-painted powder-coat finish, available in standard and shallow heights. Offered in black, silver, white, or any custom RAL color.

OPTICAL PERFORMANCE

The optical system features an upper TIR optic for precise beam control, with an optional Solite or soft-focus lens to diffuse the source and deliver smooth, striation-free distribution. A patented lens further refines the beam angle. All optics are field-changeable and offered in a range of beam distributions.

SUSPENSION SYSTEM

A standard 5-inch shallow ceiling-mount canopy is provided for direct installation to 3-1/4" to 4" octagonal or square junction boxes. The pendant-mount option includes a 10 ft adjustable aircraft cable and power cord, both field-adjustable to the desired length. Consult factory for custom mounting or stem options.

TRIM CONSTRUCTION

With dual trim construction and an extensive library of finish options, BOLD trims empower lighting designers to achieve both technical precision and visual harmony in any space.

Anodized Aluminum: Designed for visual comfort, anodized trims recess the light source to achieve a 35-degree cutoff, enhancing glare control and supporting quiet ceilings in high-performance architectural environments. The electrochemical finish ensures long-term reflectance and material integrity.

Die-Cast: Die-cast trims provide sharp detailing, precise fit, and the ability to seamlessly blend into the ceiling plane with high-quality painted finishes. Ideal for minimalist spaces where integration and consistency are key

THERMAL MANAGEMENT SYSTEM

Passive-cooling die-cast aluminum heat sink dissipates heat from the LED module, supporting optimal performance and extending component life.

OPTICAL FILTER & ACCESSORIES

Additional lens accessories—including Frosted, Soft Focus, Spread, Honeycomb, Linear, and Solite—help meet specific design and performance requirements. Up to two accessories may be used per luminaire, and they are intended only for open, non-lensed downlight trims.

OPERATING TEMPERATURE

Luminaire must be installed and operated in damp or dry locations with an ambient temperature range of -4°F to 104°F (-20°C to 40°C).

MOUNTING

Offered in cable, stem, and surface mounting options. Cable and pendant mounts are supplied with a complete canopy assembly matched to the housing finish, and cable height can be field-adjusted up to 10 ft.

EMERGENCY OPTIONS/CONTROLS

The remote test switch is included. The external battery operates LED loads of up to 1000 lumens (EMG-SDTLED-10W) or up to 2000 lumens (EMG-LED-20W).

DIM TO WARM OPTION

Dims to Warm simulates traditional incandescent halogen lighting through dimming. When the luminaire dims to warm from 100% to .1%, it makes a smooth transition across the black body radiator while maintaining a constant CRI of 90+. Available in 30K-18K, 30K-22K or 27K-18K range.

XICATO ARTIST SERIES LED MODULE (XIA)

Powered by Xicato Artist Series®, which are tested to IES TM-30-15, with a color fidelity score (Rf) of 96 and a color gamut score (Rg) of 102, and color shift less than du'v' of 0.003. Featuring cold phosphor technology, improving thermal management enhancing color consistency and delaying lumen depreciation.

!NATURAL SPECTRUM (NSL)

Natural Spectrum LED option is designed for Human Centric lighting application. Natural Spectrum LEDs diminish blue light peak, similar spectral curve to sunlight, accurate rendering of colors and reduced scattered reflection and glare.

3"

3" Suspended Mount Architectural Cylinders

BOLD-3-CYL-ADJ-SM

Bold Cylinders Series

DIMMING & DRIVER INFORMATION

🔗 **DIM10** - 0-10V dimming on either MVOLT 120, 277 or 347V. Dimmable down to 1% of initial lumens, standard

🔗 **LUTH** - Lutron LDE1 Hi-Lume Eco System with Soft Fade to Black 1% dimming

🔗 **LUTFTB** - Lutron PEQ0 Hi-Lume Premier Eco System LED Driver with soft-on fade to black 0.1% dimming

🔗 **ELDO10.1-LIN** - ELDO10-Linear with linear dimming curve.

🔗 **ELDODMX.1** - EldoLED PowerDrive dimming down to 0.1%. Please see EldoLED website for wiring diagrams and a list of compatible DMX and DALI control systems.

🔗 **ELDODALI.1** - EldoLED SoloDrive DALI-2. Dimming down to 0.1%

🔗 **DIMTR** - Triac & Electronic low voltage forward phase dimming. Available in 120V only

🔗 **BLE-CASAMBI** - Luminaires may be controlled, grouped, scheduled or placed in scenes, and or zones Via Cassambi Bluetooth 4.0 App.

🔗 **POE** - Power-over-Ethernet Depending on the PoE manufacturer selected

🔗 **DIM10-0-OFF** - Program DIM10-to OFF with linear dimming curve 0.1%

🔗 **ELDO10-LOG** - ELDO10-LOG with logarithmic dimming curve.

🔗 **XSR** - Xitanium SR Dimming

🔗 **DIM10-AUX** - 0-10V with Auxiliary power

🔗 **DIMTR** - Triac & Electronic low voltage forward phase dimming. Available in 120V only

WARRANTY

Five-year warranty for parts and components.
(Labor not included)

LISTINGS

- BABAA Compliant for government procurement under FAR, DFARS, and DOT regulations.

3"

3" Suspended Mount Architectural Cylinders

BOLD-3-CYL-ADJ-SM

Bold Cylinders Series

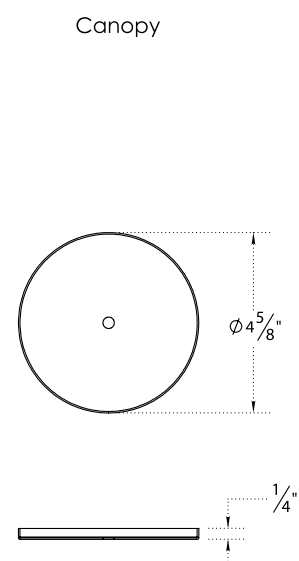
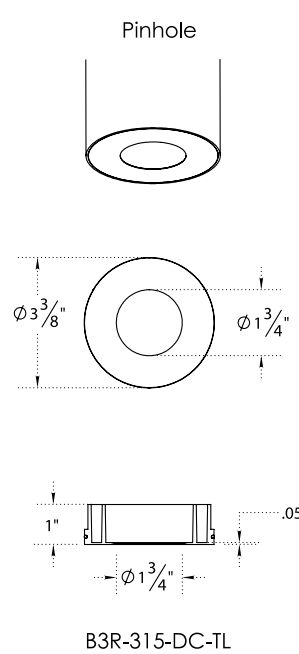
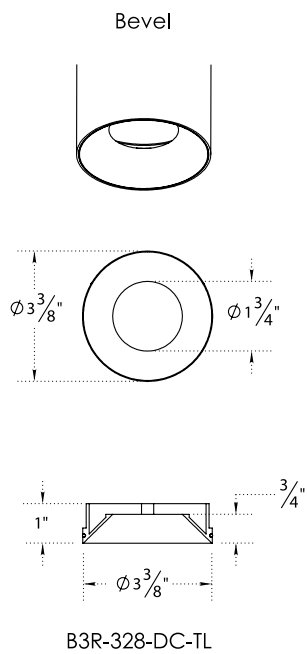
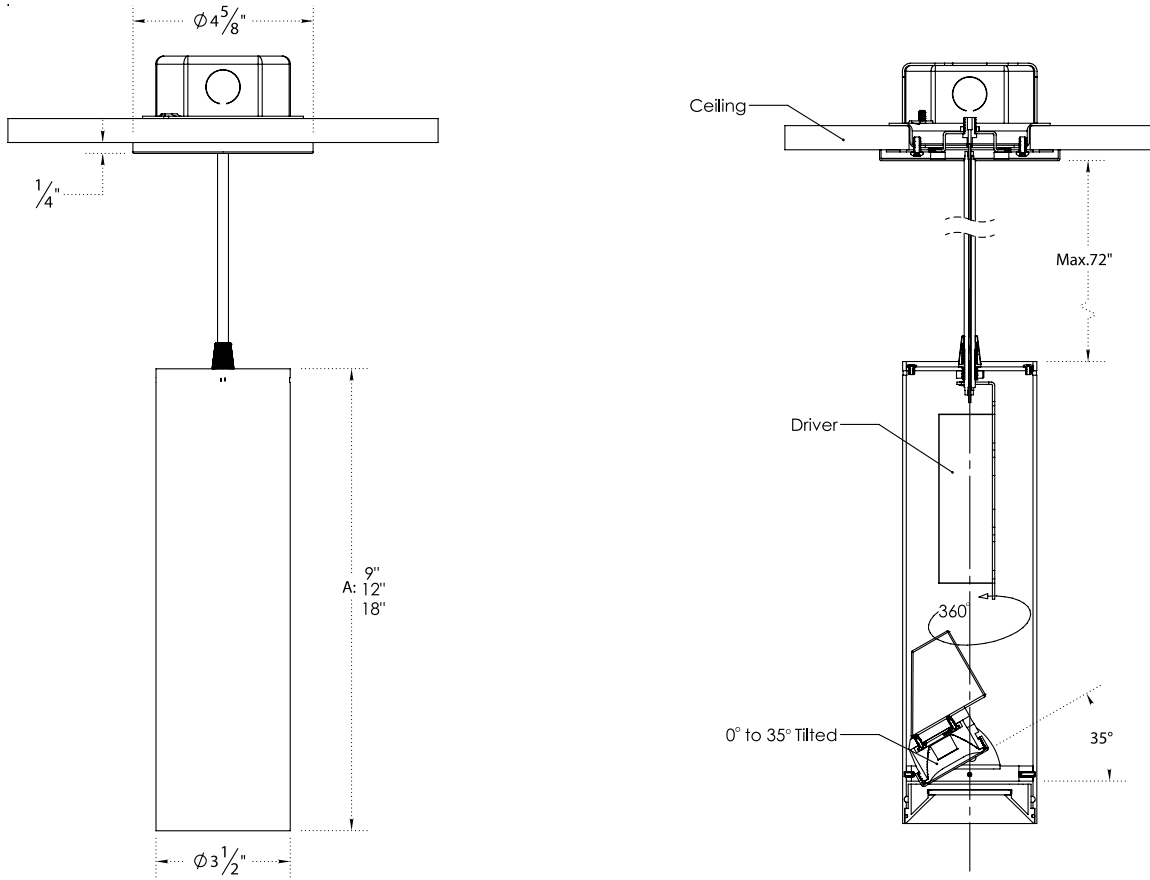

3"

BOLD-3-CYL-ADJ-SM

3" Suspended Mount Architectural Cylinders

Bold Cylinders Series

BOLD-3-CYL-ADJ-SM-2000L-40K-90-15D-DIM10-MVOLT-B3R-318-A-F-CL-WH

TEST NOEPL02242531

INPUT WATTS: **22.8**

LUMENS: **2105**

EFFICACY: **92**

BEAM ANGLE: **15**

SPACING CRITERIA: **0.32**

CANDELA DISTRIBUTION

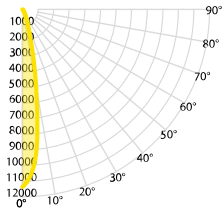

CANDELA TABLE

	0°	90°
0°	11382	11393
10°	5042	6312
20°	1037	1320
30°	297	383
40°	90	110
50°	21	24
60°	2	2
70°	0	0
80°	0	0
90°	0	0

LUMINANCE (cd/sq.m)

	0.00°	90.00°
0.00°	974957	975861
10°	5204	5789
20°	1201	1419
30°	30	28
40°	23	23
50°	39	39
60°	2	2
70°	0	0
80°	0	0
90°	0	0

LUMENS PER ZONE

ZONE	LUMENS
0° - 10°	831
10° - 20°	778
20° - 30°	317
30° - 40°	125
40° - 50°	41
50° - 60°	10
60° - 70°	1
70° - 80°	0
80° - 90°	0

ZONAL LUMEN SUMMARY

ZONE	UMENS	% LUMINAIRE
0° - 20°	1610	76%
0° - 30°	1926	92%
0° - 40°	2051	97%
0° - 60°	2102	100%
0° - 80°	2103	100%
0° - 90°	2103	100%

CONE OF LIGHT

MOUNTING HEIGHT	FC AT BEAM CENTER	BEAM DIA. 0° -180°	BEAM DIA. 90° -270°
6.0 ft	316.2 fc	2.2 ft	2.2 ft
8.0 ft	177.8 fc	3.0 ft	3.0 ft
10.0 ft	113.8 fc	3.7 ft	3.7 ft
12.0 ft	79.0 fc	4.4 ft	4.4 ft
14.0 ft	58.1 fc	5.2 ft	5.2 ft
16.0 ft	44.5 fc	5.9 ft	5.9 ft
18.0 ft	35.1 fc	6.6 ft	6.6 ft
20.0 ft	28.5 fc	7.4 ft	7.4 ft

INDOOR COEFFICIENTS OF UTILIZATION

pf	pc	20%																0%				
		80%				70%				50%				30%					10%		0%	
pw	70%	50%	30%	10%	70%	50%	30%	10%	50%	30%	10%	50%	30%	10%	50%	30%	10%	50%	30%	10%	0%	
0	120	120	120	120	118	118	118	118	112	112	112	108	108	108	108	103	103	103	103	103	103	101
1	116	114	112	110	114	112	110	109	108	107	105	104	103	102	101	100	99	98	98	97	96	94
2	112	109	106	103	110	107	104	102	104	102	100	101	99	98	96	94	96	94	92	91	89	88
3	109	104	100	97	107	103	99	97	100	97	95	98	96	94	96	94	92	91	89	88	86	85
4	105	100	96	93	104	99	95	92	97	94	91	95	92	90	93	91	89	88	86	84	83	
5	102	96	92	89	101	95	91	89	94	90	88	92	89	87	91	88	86	84	83	81	80	
6	99	93	89	86	98	92	88	85	91	87	85	90	87	84	88	86	84	83	81	80	78	
7	96	90	86	83	95	89	85	82	88	85	82	87	84	82	86	83	81	80	78	76	74	
8	94	87	83	80	93	87	83	80	86	82	80	85	82	79	84	81	79	78	76	74	72	
9	91	85	80	78	90	84	80	78	83	80	77	83	79	77	82	79	77	76	74	72	70	
10	89	82	78	76	88	82	78	75	81	78	75	81	77	75	80	77	75	74	72	70	68	

BOLD-3-CYL-ADJ-SM-2000L-40K-90-26D-DIM10-MVOLT-B3R-318-A-F-CL-WH

TEST NOEPL02242531

INPUT WATTS: **22.8**

LUMENS: **2189**

EFFICACY: **96**

BEAM ANGLE: **24**

SPACING CRITERIA: **0.41**

CANDELA DISTRIBUTION

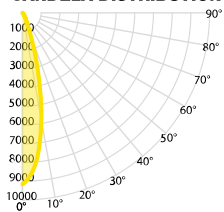

CANDELA TABLE

	0°	90°
0°	9156	9205
10°	5800	6438
20°	1275	1604
30°	290	357
40°	94	118
50°	23	30
60°	1	3
70°	0	0
80°	0	0
90°	0	0

LUMINANCE (cd/sq.m)

	0.00°	90.00°
0.00°	784230	788471
10°	5518	6902
20°	1213	1846
30°	28	73
40°	23	26
50°	39	39
60°	1	3
70°	0	0
80°	0	0
90°	0	0

LUMENS PER ZONE

ZONE	LUMENS
0° - 10°	746
10° - 20°	937
20° - 30°	326
30° - 40°	120
40° - 50°	46
50° - 60°	12
60° - 70°	1
70° - 80°	0
80° - 90°	0

ZONAL LUMEN SUMMARY

ZONE	UMENS	% LUMINAIRE
0° - 20°	1683	77%
0° - 30°	2009	92%
0° - 40°	2129	97%
0° - 60°	2186	100%
0° - 80°	2187	100%
0° - 90°	2187	100%

CONE OF LIGHT

MOUNTING HEIGHT	FC AT BEAM CENTER	BEAM DIA. 0° -180°	BEAM DIA. 90° -270°
6.0 ft	254.3 fc	2.8 ft	2.8 ft
8.0 ft	143.1 fc	3.7 ft	3.7 ft
10.0 ft	91.6 fc	4.6 ft	4.6 ft
12.0 ft	63.6 fc	5.5 ft	5.5 ft
14.0 ft	46.7 fc	6.5 ft	6.5 ft
16.0 ft	35.8 fc	7.4 ft	7.4 ft
18.0 ft	28.3 fc	8.3 ft	8.3 ft
20.0 ft	22.9 fc	9.2 ft	9.2 ft

INDOOR COEFFICIENTS OF UTILIZATION

pf	pc	20%																0%			
		80%				70%				50%				30%					10%		0%
pw	70%	50%	30%	10%	70%	50%	30%	10%	50%	30%	10%	50%	30%	10%	50%	30%	10%	50%	30%	10%	0%
0	120	120	120	120	117	117	117	117	112	112	112	107	107	107	103	103	103	103	103	103	101
1	116	114	112	110	113	111	110	108	107	106	105	104	103	102	100	99	99	99	99	99	97
2	112	108	105	102	110	106	104	101	103	101	99	100	98	97	98	96	95	95	95	93	91
3	108	103	99	96	106	102	98	96	99	97	94	97	95	93	95	93	91	90	88	87	85
4	105	99	95	92	103	98	94	91	96	93	90	94	91	89	92	90	88	87	85	84	82
5	101	95	91	88	100	94	90	87	93	89	87	91	88	86	90	87	85	84	82	81	79
6	98	92	87	84	97	91	87	84	90	86	83	88	85	83	87	84	82	81	79	78	76
7	95	89	84	81	94	88	84	81	87	83	81	86	83	80	85	82	80	79	77	76	74
8	92	86	81	78	92	85	81	78	84	81	78	83	80	78	82	80	78	77	76	74	72
9	90	83	79	76	89	83	79	76	82	78	76	81	78	75	80	77	75	74	72	70	68
10	88	81	76	74	87	80	76	74	80	76	73	79	76	73	78	75	73	72	70	68	66



3"

BOLD-3-CYL-ADJ-SM

3" Suspended Mount Architectural Cylinders

Bold Cylinders Series

BOLD-3-CYL-ADJ-SM-2000L-40K-90-36D-DIM10-MVOLT-B3R-318-A-F-CL-WH

TEST NO: **EPL02242531**

INPUT WATTS: **21.7**

LUMENS: **2364**

EFFICACY: **109**

BEAM ANGLE: **36**

SPACING CRITERIA: **0.61**

CANDELA DISTRIBUTION

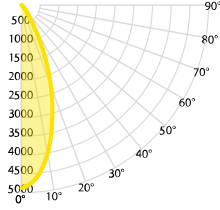

CANDELA TABLE

	0°	90°
0°	4880	4891
10°	4020	4203
20°	2302	2549
30°	724	876
40°	166	182
50°	42	45
60°	7	7
70°	0	0
80°	0	0
90°	0	0

LUMINANCE (cd/sq.m)

	0.00°	90.00°
0.00°	743047	744724
45.00°	17394	18484
55.00°	5289	5575
65.00°	126	256
75.00°	53	59
85.00°	87	87

LUMENS PER ZONE

ZONE	LUMENS
0° - 10°	446
10° - 20°	885
20° - 30°	689
30° - 40°	250
40° - 50°	71
50° - 60°	20
60° - 70°	2
70° - 80°	0
80° - 90°	0

ZONAL LUMEN SUMMARY

ZONE	UMENS	% LUMINAIRE
0° - 20°	1330	56%
0° - 30°	2019	85%
0° - 40°	2268	96%
0° - 60°	2360	100%
0° - 80°	2362	100%
0° - 90°	2362	100%

CONE OF LIGHT

MOUNTING HEIGHT	FC AT BEAM CENTER	BEAM DIA. 0° -180°	BEAM DIA. 90° -270°
6.0 ft	135.5 fc	4.3 ft	4.3 ft
8.0 ft	76.2 fc	5.7 ft	5.8 ft
10.0 ft	48.8 fc	7.2 ft	7.2 ft
12.0 ft	33.9 fc	8.6 ft	8.7 ft
14.0 ft	24.9 fc	10.0 ft	10.1 ft
16.0 ft	19.1 fc	11.4 ft	11.6 ft
18.0 ft	15.1 fc	12.9 ft	13.0 ft
20.0 ft	12.2 fc	14.3 ft	14.4 ft

INDOOR COEFFICIENTS OF UTILIZATION

pf	pc	20%																0%	
		80%				70%				50%				30%					10%
pw	70%	50%	30%	10%	70%	50%	30%	10%	50%	30%	10%	50%	30%	10%	50%	30%	10%	0%	
0	119	119	119	119	117	117	117	117	111	111	111	107	107	107	102	102	102	102	100
1	115	112	110	108	112	110	108	106	106	104	103	102	101	100	99	98	97	95	95
2	110	105	102	99	108	104	101	98	101	98	96	98	96	94	95	93	92	90	90
3	105	100	95	92	103	98	94	91	96	92	90	93	91	88	91	89	87	85	85
4	101	94	89	86	99	93	89	85	91	87	84	89	86	83	87	85	82	81	81
5	97	89	84	81	95	89	84	80	87	83	80	85	82	79	84	81	78	77	77
6	93	85	80	76	91	84	79	76	83	79	75	82	78	75	80	77	74	73	73
7	89	81	76	72	88	80	76	72	79	75	72	78	74	71	77	74	71	70	70
8	86	77	72	69	85	77	72	69	76	71	68	75	71	68	74	70	68	67	67
9	82	74	69	65	81	74	69	65	73	68	65	72	68	65	71	67	65	64	64
10	79	71	66	63	78	71	66	62	70	65	62	69	65	62	68	65	62	61	61

BOLD-3-CYL-ADJ-SM-2000L-40K-90-60D-DIM10-MVOLT-B3R-318-A-F-CL-WH

TEST NO: **EPL02242531**

INPUT WATTS: **21.7**

LUMENS: **2264**

EFFICACY: **104**

BEAM ANGLE: **60**

SPACING CRITERIA: **0.80**

CANDELA DISTRIBUTION

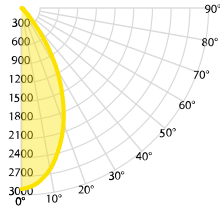

CANDELA TABLE

	0°	90°
0°	2907	2908
10°	2630	2718
20°	1971	2097
30°	1123	1242
40°	290	368
50°	36	38
60°	7	5
70°	0	0
80°	0	0
90°	0	0

LUMINANCE (cd/sq.m)

	0.00°	90.00°
0.00°	442703	442843
45.00°	21822	26949
55.00°	4407	4030
65.00°	133	76
75.00°	59	53
85.00°	87	70

LUMENS PER ZONE

ZONE	LUMENS
0° - 10°	281
10° - 20°	657
20° - 30°	731
30° - 40°	459
40° - 50°	114
50° - 60°	17
60° - 70°	2
70° - 80°	0
80° - 90°	0

ZONAL LUMEN SUMMARY

ZONE	UMENS	% LUMINAIRE
0° - 20°	938	41%
0° - 30°	1669	74%
0° - 40°	2128	94%
0° - 60°	2259	100%
0° - 80°	2262	100%
0° - 90°	2262	100%







CONE OF LIGHT

MOUNTING HEIGHT	FC AT BEAM CENTER	BEAM DIA. 0° -180°	BEAM DIA. 90° -270°
6.0 ft	80.8 fc	6.1 ft	6.1 ft
8.0 ft	45.4 fc	8.1 ft	8.1 ft
10.0 ft	29.1 fc	10.2 ft	10.2 ft
12.0 ft	20.2 fc	12.2 ft	12.2 ft
14.0 ft	14.8 fc	14.2 ft	14.3 ft
16.0 ft	11.4 fc	16.3 ft	16.3 ft
18.0 ft	9.0 fc	18.3 ft	18.3 ft
20.0 ft	7.3 fc	20.3 ft	20.4 ft

INDOOR COEFFICIENTS OF UTILIZATION

pf	pc	20%																0%	
		80%				70%				50%				30%					10%
pw	70%	50%	30%	10%	70%	50%	30%	10%	50%	30%	10%	50%	30%	10%	50%	30%	10%	0%	
0	119	119	119	119	116	116	116	116	111	111	111	106	106	106	102	102	102	102	100
1	114	111	109	107	111	109	107	105	105	103	102	101	100	99	98	97	96	94	94
2	108	104	100	97	106	102	98	95	99	96	93	96	93	91	93	91	89	88	88
3	103	97	92	88	101	96	91	88	93	89	86	91	87	85	88	86	84	82	82
4	98	91	86	81	96	90	85	81	88	83	80	86	82	79	84	81	78	77	77
5	93	85	80	76	92	84	79	75	83	78	75	81	77	74	79	76	73	72	72
6	89	80	75	70	87	80	74	70	78	73	70	77	72	69	75	72	69	67	67
7	85	76	70	66	83	75	70	66	74	69	65	73	68	65	71	68	65	63	63
8	81	72	66	62	80	71	65	62	70	65	61	69	64	61	68	64	61	59	59
9	77	68	62	58	76	67	62	58	66	61	58	65	61	58	65	60	57	56	56
10	74	64	59	55	73	64	58	55	63	58	55	62	58	54	61	57	54	53	53



BRAND							
CONTROL UNIT	<input type="checkbox"/> FCJS-010 Lutron Vive 0-10V Individual Pow Pak (Luminare is shipped Vive Enabled) 1 4	<input type="checkbox"/> CU-4E-FMH Fixture Mount Control Unit 1 5	<input type="checkbox"/> ZL027-NOW Intellect Power Control Module 1 6	<input type="checkbox"/> EN-WCM2-ZB-DR Wireless Control Module 1 7	<input type="checkbox"/> XITANIUM SR LED DRIVER The Philips Advance Xitanium SR LED driver 1 8	<input type="checkbox"/> LMFC-011 ON/OFF/0-10V dimming fixture controller 1 9	<input type="checkbox"/> NXFM-1R2D-OUNV NX Fixture Module, Offset, 1 Relay, 2 0-10V Dimming Channels, 120-347VAC, Blue
	<input type="checkbox"/> FCJS-ECO Lutron Vive Eco-system Pow Pak (Luminare is shipped Vive Enabled)						
	<input type="checkbox"/> A-WN-D01-RF-WH Athena wireless node (RF only) (White)						
	<input type="checkbox"/> A-WN-D01-OCC-WH Athena wireless node with sensor (White)						
INTEGRATED OCCUPANCY & DAYLIGHT SENSOR	<input type="checkbox"/> DFCSJ-OEM-OCC Clear Connect (RF) and Occupancy/Daylight Sensing 2	<input type="checkbox"/> SU-5E-IoT IoT Node Micro Sensor	<input type="checkbox"/> ZL00J-TOW Intellect Intelligent Fixture Control System 2	<input type="checkbox"/> EN-CLM-PIR-DD-ZB SensiLUM™ Wireless Integrated Sensor	<input type="checkbox"/> SNS 212 EasyAir Daylight and Occupancy sensor	<input type="checkbox"/> FD-301 Fixture integrated Daylight Dimming Sensor 2	<input type="checkbox"/> NXRMM HubbNETM Radio Module
		<input type="checkbox"/> SU-5E-CL Connected Micro Sensor					
		<input type="checkbox"/> SU-5E-IL Independent Micro Sensor					
		<input type="checkbox"/> SU-5S-H(IoT/CL/IL) Surface Mount Sensor 2 <i>Must be Specified with CU-4E-FMH Control Unit</i>	<input type="checkbox"/> ZL00J-DOW Intellect Intelligent Fixture Control System 2	<input type="checkbox"/> ZBHACLIM-DIM-ENC Connected Lighting Module DIM 2		<input type="checkbox"/> SNS300 SNS300 for networks 2	
* WIRELESS OCCUPANCY SENSOR	<input type="checkbox"/> LRF2-OCR2B-P-WH Ceiling mount 360°, occupancy/vacancy sensor 3	N/A	N/A	<input type="checkbox"/> EN-SCPPH-1500-ZB Wireless Passive Infrared Occupancy and Photo Sensors 3	N/A	<input type="checkbox"/> LMDC-100 Dual technology PIR Ceiling Mount Occupancy Sensor 3	<input type="checkbox"/> NXSMP2-SMI NX Slide Mount Indoor Sensor Module
	<input type="checkbox"/> LRF2-DCRB-WH Ceiling-mount daylight sensor 3	N/A	N/A	<input type="checkbox"/> EN-SCPPH-1500-ZB Wireless Passive Infrared Occupancy and Photo Sensors 3	N/A	<input type="checkbox"/> LMLS-400 Single zone switching and dimming digital photosensor 3	<input type="checkbox"/> LUXSTATLS Luxstat Light Sensor for Luxstat Control Modules, 3 to 6000 FC
* WIRELESS OCCUPANCY & DAYLIGHT SENSOR	N/A	<input type="checkbox"/> SU-5E-IoT IoT Node Micro Sensor	<input type="checkbox"/> ZL00J-TOW Intellect Intelligent Fixture Control System	<input type="checkbox"/> EN-CLM-PIR-DD-ZB SensiLUM™ Wireless Integrated Sensor	<input type="checkbox"/> SNS212-CMP SNS-212 for Grouping 3	N/A	<input type="checkbox"/> NXSMDT Indoor Ceiling Mount Sensor - OMNI
		<input type="checkbox"/> SU-5E-CL Connected Micro Sensor					
		<input type="checkbox"/> SU-5E-IL Independent Micro Sensor					
		<input type="checkbox"/> SU-5S-H (IoT/CL/IL) Surface Mount Sensor 3 <i>Must be specified with CU-4E-FMH Control Unit</i>	<input type="checkbox"/> ZL00J-DOW Intellect Intelligent Fixture Control System 3 <i>Must be specified with ZL027-NOW and ZL00JDOW Control unit</i>	<input type="checkbox"/> ZBHACLIM-DIM-ENC Connected Lighting Module DIM 3 <i>Must be specified with EN-WCM2-ZB-DR or EN-ALC-ZB-BK-DR Control Unit</i>			
ACCESSORIES	N/A	<input type="checkbox"/> TMC-SU-5E Tile Mount Carrier	N/A	N/A	N/A	N/A	N/A
		<input type="checkbox"/> CBL-5E-CU4-30N 30 inch Sensor cable for CU-4 and IoT Ready					
		<input type="checkbox"/> CBL-5E-CU4-7F 7 Foot sensor cable for CU-4 and IoT Ready Driver					

- 1- Luminare will be shipped with Powerpacks pre-installed, ready to be integrated to designated control systems
- 2- Luminare will be shipped with Sensors installed on the luminare, allowing for individual luminare control. Luminaires will be ready to be integrated with designated control systems
- 3- Luminare will be shipped with Sensors to be remotely installed on the ceiling. Luminaires will be ready to be integrated with designated control systems
- 4- Luminare will be compatible with LUTRON LRF2-OCR2B-PWH Ceiling mount 360deg occupancy/vacancy sensor & LRF2-DCRB-WH ceiling mount daylight sensor. Sensors must be ordered through Lutron
- 5- Luminare will be compatible with ENLIGHTED SU-5E-IoT, SU-5E-CL, SU-5E-IL, SU-5S-H, Sensors
- 6- Luminare will be compatible with LEVITON Intellect APP & Keypad room controller
- 7- Luminare will be compatible with EN-SCPPH-1500-ZB Wireless passive infrared occupancy and photo sensor
- 8- Luminare will be compatible with philips field and wireless switch
- 9- Luminare will be compatible with DLM Room control system LMPB-100. Sensors must be ordered through Legrand.