

4"

Architectural LED Downlight

EPD-4

Edison Series

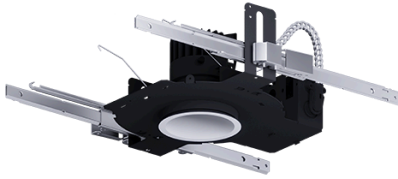

Application

A complete family of downlights, accent lights, wallwashers, double wallwashers, and corner wallwashers in multiple beam spreads and apertures designed for commercial, civic, museums, corporate, hospitality, academic, retail, medical, and houses of worship.

Features

- Exceptional Optical Quality: Up to 98 CRI, 1×2 Step MacAdam Ellipse.
- Shipped standard with a Solite Beam Smoother lens that removes striations from the light source.
- Available with a multitude of dimming protocols and control offerings.

Nominal Lumens	Delivered Lumens	Wattage
900L	995	10
1200L	1341	14
1500L	1699	18
2000L	2144	24
3000L	3579	32

Based on 4000K, 90+ CRI with semi-specular chrome reflector.
Actual wattage may vary +/-5%

Lumens	High Performance: 900, 1200, 1500, 2000, 3000 Dims to Warm: 900, 1200, 1500, 2000 Xicato Artist: 900, 1200, 1500 Natural Spectrum: 900, 1200, 1500, 2000
CCT & Dynamic Platforms	High Performance: 22K, 27K, 30K, 35K, 40K, 50K Dims to Warm: 18K-30K Xicato Artist: 27K, 30K, 30K-VIB, 35K, 40K Natural Spectrum: 27K, 30K, 35K, 40K, 50K, 65K
CRI	High Performance: 90+, 98+ Dims to Warm: 90+ Xicato Artist: 98+ Natural Spectrum: 97+
Color Quality	2 Step MacAdam Ellipse
Distributions	NSPD (Narrow Spot 15°), SPD (Spot 24°), ND (Narrow 30°), MD (Medium 36°), MWD (Medium Wide 52°), WD (Wide 60°), VWD (Very Wide 70°)
Trim Options	Downlight, Wall Wash, Double Wall Wash, Corner Wall Wash, Wet Location
Reflector Colors	CL (Semi-Specular Chrome), SHZ (Low Iridescent Satin Haze), WT (Wheat), W (White), BK (Black), BZ (Bronze)
Flange Colors	TL (Trimless), WH (Self-Flanged White), SCH (Self-Flanged Semi-Specular Chrome), SHZ (Self-Flanged Low Iridescent Satin Haze), BK (Self-Flanged Black), BZ (Self-Flanged Bronze)
Dimming	DIM10, LUTH, LUTFTB, ELDO10.1-LIN, ELDODMX.1, ELDODALI.1, DIMTR, BLE-CASAMBI, POE, DIM10-0-OFF, ELDO10-LOG, XSR, DIM10-AUX
Emergency	EMG-LED-10W, EMG-LED-20W, INTG-EMG-LED-10W, INTG-EMG-LED-20W, EMG-LED-G2-10W-SDT



WWW.EPL.COM | 718.685.0700 | NEW YORK / LOS ANGELES

Last Update: Oct 13, 2025 - 13:22:18 ©Ali

4"

Architectural LED Downlight

EPD-4

Edison Series

PART NUMBER: **EPD-4-900L-22K-90-NSPD-DIM10-120V**

Series	Lumens	CCT	CRI	Optics	Driver	Voltage	Emergency	Options
EPD-4	900L 1200L 1500L 2000L 3000L	22K 27K 30K 35K 40K 50K¹	90+ 98+²	NSPD Narrow Spot (15°) SPD Spot (24°) ND Narrow (30°) MD Medium (36°) MWD Medium Wide (52°) WD Wide (60°) VWD Very Wide (70°)	DIM10 LUTH LUTFTB⁴ ELDO10.1-LIN ELDODMX.1 ELDODALI.1 DIMTR³ BLE-CASAMBI POE DIM10-0-OFF ELDO10-LOG XSR DIM10-AUX	120V 277V MVOLT 347V⁵	- EMG-LED-10W EMG-LED-20W INTG-EMG-LED-10W INTG-EMG-LED-20W EMG-LED-G2-10W-SDT	- CP⁶ USA

¹ 50K series are available with 85+ CRI only ² 98+ CRI is available in 27K, 30K and 40K only ³ DIMTR available in 120V only
⁴ LUTFTB Available for luminaires up to 1500L ⁵ 347V is available in only DIM10 ⁶ CP Available for luminaires up to 1500L

PART NUMBER: **EPD-4-WDM-18K-30K-900L-90-NSPD-DIMTR-120V**

Series	Technology	Lumens	CRI	Optics	Driver	Voltage	Emergency	Options
EPD-4-WDM <i>(Dim to Warm)</i>	18K-30K	900L 1200L 1500L 2000L	90+	NSPD Narrow Spot (15°) SPD Spot (24°) ND Narrow (30°) MD Medium (36°) MWD Medium Wide (52°) WD Wide (60°) VWD Very Wide (70°)	DIMTR¹ DIM10 LUTH ELDO10.1 ELDODALI.1 ELDODMX.1	120V 277V MVOLT 347V²	- EMG-LED-10W EMG-LED-20W INTG-EMG-LED-10W INTG-EMG-LED-20W EMG-LED-G2-10W-SDT	- CP³ USA

¹ DIMTR available in 120V only ² 347V is available in only DIM10 ³ CP Available for luminaires up to 1500L

4"

Architectural LED Downlight

EPD-4

Edison Series

PART NUMBER: **EPD-4-XIA-900L-27K-98-NSPD-DIM10-120V**

Series	Lumens	CCT	CRI	Optics	Driver	Voltage	Emergency	Options
EPD-4-XIA <i>(Xicato Artist)</i>	900L 1200L 1500L	27K 30K 30K-VIB 35K 40K	98+	NSPD Narrow Spot (15°) SPD Spot (24°) ND Narrow (30°) MD Medium (36°) MWD Medium Wide (52°) WD Wide (60°) VWD Very Wide (70°)	DIM10 LUTH LUTFTB⁴ ELDO10.1-LIN ELDODMX.1 ELDODALI.1 DIMTR³ BLE-CASAMBI POE DIM10-0-OFF ELDO10-LOG XSR DIM10-AUX	120V 277V MVOLT 347V³	- EMG-LED-10W EMG-LED-20W INTG-EMG-LED-10W INTG-EMG-LED-20W EMG-LED-G2-10W-SDT	- CP⁴ USA

1 DIMTR available in 120V only **2** LUTFTB Available for luminaires up to 1500L **3** 347V is available in only DIM10 **4** CP Available for luminaires up to 1500L

PART NUMBER: **EPD-4-NSL-900L-27K-97-NSPD-DIM10-120V**

Series	Lumens	CCT	CRI	Optics	Driver	Voltage	Emergency	Options
EPD-4-NSL <i>(Natural Spectrum)</i>	900L 1200L 1500L 2000L	27K 30K 35K 40K 50K 65K	97+	NSPD Narrow Spot (15°) SPD Spot (24°) ND Narrow (30°) MD Medium (36°) MWD Medium Wide (52°) WD Wide (60°) VWD Very Wide (70°)	DIM10 LUTH LUTFTB⁴ ELDO10.1-LIN ELDODMX.1 ELDODALI.1 DIMTR³ BLE-CASAMBI POE DIM10-0-OFF ELDO10-LOG XSR DIM10-AUX	120V 277V MVOLT 347V³	- EMG-LED-10W EMG-LED-20W INTG-EMG-LED-10W INTG-EMG-LED-20W EMG-LED-G2-10W-SDT	- CP⁴ USA

1 DIMTR available in 120V only **2** LUTFTB Available for luminaires up to 1500L **3** 347V is available in only DIM10 **4** CP Available for luminaires up to 1500L

























4"

Architectural LED Downlight

EPD-4

Edison Series

ORDER GUIDE

REFLECTOR TYPE				MOUNTING	COLOR					
REFLECTOR TYPE				MOUNTING	COLOR					
Open Downlight EPD-4-401 	Wall Wash EPD-4-407 	Double Wall Wash EPD-4-477 	Corner Wall Wash EPD-4-427 	Flanged 	ANODIZED FLANGED					
					Clear White CL-WH 	Clear Bronze CL-BZ 	Black White BK-WH 	Satin Haze SHZ-SHZ 	Wheat WT-WT 	
					Clear Semi-Spec CL-SCH 	Satin Haze White SHZ-WH 	Black BK-BK 	Satin Haze Black SHZ-BK 		
					Clear Black CL-BK 	White WH-WH 	Bronze BZ-BZ 	Wheat White WT-WH 		
Open Downlight EPD-4-TL-401 	Wall Wash EPD-4-TL-407 			Trimless 	ANODIZED TRIMLESS					
					White WH 	Black BK 	Clear CL 	Satin Haze SHZ 		



Modifications Available

Consult factory for modification requests; orders may require shop drawing approval.

Downlight

Our signature anodized reflector, spun to a reverse parabola design, achieves a 50° shielding angle and a 40° cut-off, which eliminates inter-reflections, and enhances low aperture brightness

Wall Wash

The optical assembly delivers uniform ceiling-to-floor wallwashing without creating any visible scallops. The optical assembly is specially designed to extend a beam in two directions for a uniform floor-to-ceiling and side-to-side wash of light.

Double Wall Wash

Used in a corridor to wash both walls, providing both horizontal and vertical illumination that fully illuminates corridors and hallways.

Corner Wall Wash

Replacing the effect that two luminaires provide, a corner wallwasher kicks light across corners that run perpendicular to one another, ultimately providing a 210° wash of light fully covering conjoined walls and surfaces.

Optical Performance and Trim

Spun aluminum anodized single piece reflector. The optical system consists of 1) an upper reflector for a precise beam spread; 2) a solite soft focus lens to diffuse the light source for smooth, striation-free distribution; 3) and a patented lens to control the beam angle and provide a 40° visual cutoff. Available in a variety of beam angles. Integral heatsink comes preinstalled on the housing for maximum heat dissipation and locks together with the reflector to prevent zero light leakage for above the ceiling.

Fully Servicable - Easy Installation & Upgrading

Housing maybe installed in ceilings of up to 1-1/2 inch thickness without the use of additional collars. Torsion springs on EPCh side of the reflector hold snug to the ceiling, and allows for fast, easy installation into housing, and fast removal for easy access to the junction box from below the ceiling.

Trim Design

Luminaire is designed for installation in sheetrock or T-Bar ceilings to achieve a flush trim detail.

- Trimless option has a perforated face. Installation includes the application of drywall compound over the luminaire's integral spackle screen to the rim of its integral plaster ring.

Housing / Mounting

16-gauge steel, preassembled one-piece construction with integral 27" C-channel mounting brackets included. Mounting brackets may be adjusted up to 28" horizontally, and 2-3/4" vertically, and locking into place.

Emergency Options/Controls

The test switch for the emergency battery can be installed on the side of the reflector (integral INTG-EMG option), or the test switch can be mounted remotely (EMG-LED option). Self Diagnostic emergency option available (EMG-SDT-LED-10W) Typical lumen output of the luminaire is up to 1000L with EMG-LED-10W or INTG-EMG-LED-10W option & 2000L with EMG-LED-20W or INTG-EMG-LED-20W option in emergency mode. Other accessories and controls systems include modular wiring systems, daylight harvesting controls, occupancy sensors, and/or power packs for individual or room control applications.

Drivers

120/277V 50/60Hz; 347V available. THD < 20%; power factor >.09. Thermally protected. Removal of the reflector provides complete accessibility to the junction box, driver and internal components from above and below the ceiling through the aperture.

Dim to Warm Option

Dims to Warm simulates traditional incandescent halogen lighting through dimming. When the luminaire dims to warm from 100% to .1%, it makes a smooth transition across the black body radiator while maintaining a constant CRI of 90+. Available in 18K-30K range.

Xicato Artistt Series LED Module (XIA)

Powered by Xicato Artist Series®, which are tested to IES TM-30-15, with a color fidelity score (Rf) of 96 and a color gamut score (Rg) of 102, and color shift less than du'v' of 0.003. Featuring cold phosphor technology, improving thermal management enhancing color consistency and delaying lumen depreciation.

Natural Spectrum (NSL)

Natural Spectrum LED option id designed for Human Centric lighting application. Natural Spectrum LEDs diminish blue light peak, similar spectral curve to sunlight, accurate rendering of colors and reduced scattered reflection and glare.

Dimming & Driver Information

DIM10 - 0-10V dimming on either MVOLT 120, 277 or 347V. Dimmable down to 1% of initial lumens, standard

LUTH - Lutron LDE1 Hi-Lume Eco System with Soft Fade to Black 1% dimming

LUTFTB - Lutron PEQO Hi-Lume Premier Eco System LED Driver with soft-on fade to black 0.1% dimming

ELDO10.1-LIN - ELDO10-Linear with linear dimming curve.

ELDODMX.1 - EldoLED PowerDrive dimming down to 0.1%. Please see EldoLED website for wiring diagrams and a list of compatible DMX and DALI control systems.

ELDODALI.1 - EldoLED SoloDrive DALI-2.

Dimming down to 0.1%

DIMTR - Triac & Electronic low voltage forwardp hase dimming. Available in 120V only

BLE-CASAMBI - Luminaires may be controlled, grouped, scheduled or placed in scenes , and or zones Via Cassambi Bluetooth 4.0 App.

POE - Power-over-Ethernet Depending on the PoE manufacturer selected

DIM10-O-OFF - Program DIM10-to OFF withlinear dimming curve 0.1%

ELDO10-LOG - ELDO10-LOG with logarithmic dimming curve.

XSR - Xitanium SR Dimming

DIM10-AUX - 0-10V with Auxiliry power

ELDO10.1 - EldoLED SoloDrive 0-10V. Dimming down to 0.1%

4"

Architectural LED Downlight

EPD-4

Edison Series

FLANGED

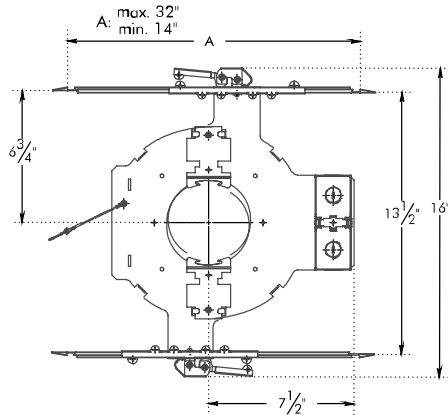
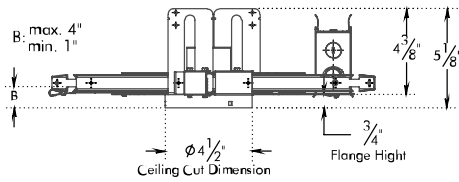
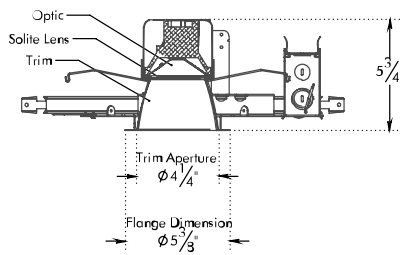
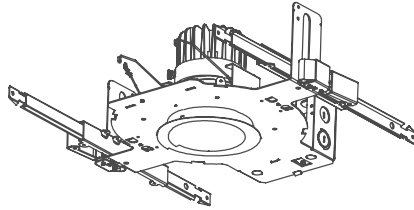

TRIMLESS

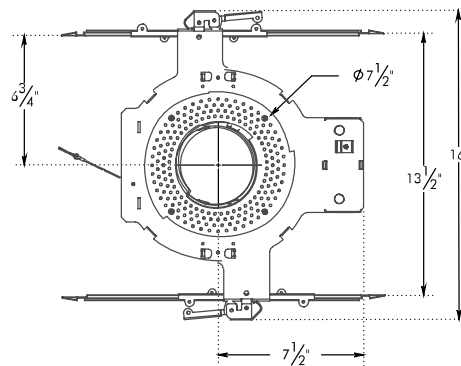
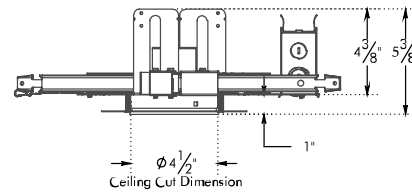
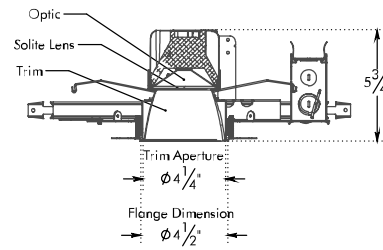
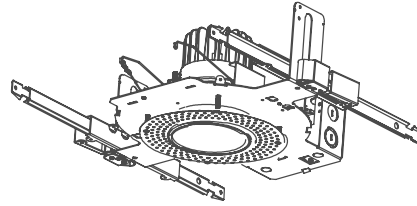

Downlight



Wall Wash

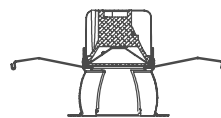

Double Wall Wash

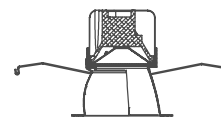

Corner Wall Wash



4"

Architectural LED Downlight

EPD-4

Edison Series

EPD-4-3000L-40K-90-NSPD-DIM10-MVOLT-EPD-4-401-F-CL-WH

TEST NO: **EPL05022201**

INPUT WATTS: **32.1**

LUMENS: **3153**

EFFICACY: **98**

BEAM ANGLE: **29**

SPACING CRITERIA: **0.42**

CANDELA DISTRIBUTION

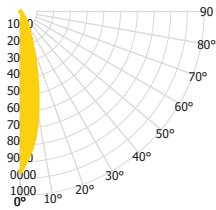

CANDELA TABLE

	0°	90°
0°	9601	9601
10°	5978	6553
20°	2033	2040
30°	737	645
40°	202	223
50°	32	39
60°	3	3
70°	1	1
80°	0	0
90°	0	0

LUMINANCE (cd/sq.m)

	0.00°	90.00°
0.00°	205607	205607
45.00°	2565	2863
55.00°	214	255
65.00°	73	85
75.00°	41	50
85.00°	7	15

LUMENS PER ZONE

ZONE	LUMENS
0° - 10°	798
10° - 20°	1304
20° - 30°	643
30° - 40°	291
40° - 50°	98
50° - 60°	15
60° - 70°	2
70° - 80°	1
80° - 90°	0

ZONAL LUMEN SUMMARY

ZONE	LUMENS	% LUMINAIRE
0° - 20°	2102	67%
0° - 30°	2745	87%
0° - 40°	3036	96%
0° - 60°	3149	100%
0° - 80°	3151	100%
0° - 90°	3151	100%

CONE OF LIGHT

MOUNTING HEIGHT	FC AT BEAM CENTER	BEAM DIA. 0°-180°	BEAM DIA. 90°-270°
6.0 ft	266.7 fc	3.1 ft	3.1 ft
8.0 ft	150.0 fc	4.2 ft	4.1 ft
10.0 ft	96.0 fc	5.2 ft	5.1 ft
12.0 ft	66.7 fc	6.3 ft	6.1 ft
14.0 ft	49.0 fc	7.3 ft	7.1 ft
16.0 ft	37.5 fc	8.3 ft	8.2 ft
18.0 ft	29.6 fc	9.4 ft	9.2 ft
20.0 ft	24.0 fc	10.4 ft	10.2 ft

INDOOR COEFFICIENTS OF UTILIZATION

pf	pc	20%																0%				
		80%				70%				50%				30%								
pw	70%	50%	30%	10%	70%	50%	30%	10%	50%	30%	10%	50%	30%	10%	50%	30%	10%	10%	0%			
0	119	119	119	119	116	116	116	116	111	111	111	106	106	106	102	101	100	99	98	97	95	
1	114	112	110	108	112	110	108	106	106	104	103	102	101	100	99	98	97	96	95	94	93	91
2	110	106	103	100	108	104	101	99	101	99	97	98	96	95	96	94	93	91	90	88	87	
3	106	101	97	93	104	99	96	93	97	94	91	94	92	90	92	90	88	87	85	84	83	
4	102	96	91	88	100	95	91	87	93	89	86	91	88	85	89	86	84	81	86	83	81	80
5	98	91	87	83	97	91	86	83	89	85	82	87	84	81	86	83	81	78	83	80	77	76
6	95	87	83	79	93	87	82	79	85	81	78	84	81	78	83	80	77	74	80	77	74	73
7	91	84	79	76	90	83	79	75	82	78	75	81	77	75	80	77	74	74	77	74	72	70
8	88	81	76	73	87	80	76	72	79	75	72	78	74	72	77	74	72	70	76	73	70	68
9	85	78	73	70	84	77	73	70	76	72	69	75	72	69	75	71	69	68	75	71	69	68
10	82	75	70	67	82	74	70	67	74	70	67	73	69	67	72	69	66	65	72	69	66	65

EPD-4-3000L-40K-90-SPD-DIM10-MVOLT-EPD-4-401-F-CL-WH

TEST NO: **EPL05022201**

INPUT WATTS: **32.1**

LUMENS: **3026**

EFFICACY: **94**

BEAM ANGLE: **30**

SPACING CRITERIA: **0.44**

CANDELA DISTRIBUTION

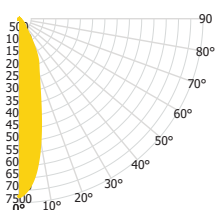

CANDELA TABLE

	0°	90°
0°	7242	7242
10°	4864	5172
20°	2219	2261
30°	778	910
40°	270	295
50°	55	66
60°	7	7
70°	2	3
80°	0	1
90°	0	0

LUMINANCE (cd/sq.m)

	0.00°	90.00°
0.00°	155070	155070
45.00°	4421	4921
55.00°	529	564
65.00°	199	220
75.00°	105	117
85.00°	12	22

LUMENS PER ZONE

ZONE	LUMENS
0° - 10°	617
10° - 20°	1049
20° - 30°	828
30° - 40°	347
40° - 50°	148
50° - 60°	28
60° - 70°	5
70° - 80°	2
80° - 90°	0

ZONAL LUMEN SUMMARY

ZONE	LUMENS	% LUMINAIRE
0° - 20°	1667	55%
0° - 30°	2494	82%
0° - 40°	2842	94%
0° - 60°	3018	100%
0° - 80°	3024	100%
0° - 90°	3025	100%

CONE OF LIGHT

MOUNTING HEIGHT	FC AT BEAM CENTER	BEAM DIA. 0°-180°	BEAM DIA. 90°-270°
6.0 ft	201.2 fc	3.3 ft	3.2 ft
8.0 ft	113.1 fc	4.4 ft	4.3 ft
10.0 ft	72.4 fc	5.5 ft	5.4 ft
12.0 ft	50.3 fc	6.5 ft	6.5 ft
14.0 ft	36.9 fc	7.6 ft	7.6 ft
16.0 ft	28.3 fc	8.7 ft	8.6 ft
18.0 ft	22.4 fc	9.8 ft	9.7 ft
20.0 ft	18.1 fc	10.9 ft	10.8 ft

INDOOR COEFFICIENTS OF UTILIZATION

pf	pc	20%																0%				
		80%				70%				50%				30%								
pw	70%	50%	30%	10%	70%	50%	30%	10%	50%	30%	10%	50%	30%	10%	50%	30%	10%	10%	0%			
0	119	119	119	119	116	116	116	116	111	111	111	106	106	106	102	102	102	102	102	100		
1	114	112	109	107	112	109	107	106	105	104	102	102	100	99	98	97	96	95	94	91	90	
2	109	105	101	98	107	103	100	97	100	97	95	97	95	93	94	93	91	90	88	86	85	
3	105	99	94	91	103	98	93	90	95	92	89	93	90	87	90	88	86	85	83	81	80	
4	100	93	89	85	98	92	88	84	90	86	83	88	85	82	87	84	82	80	77	76	75	
5	96	89	84	80	94	88	83	79	86	82	79	84	81	78	83	80	77	76	74	72	71	
6	92	84	79	75	91	83	79	75	82	78	75	81	77	74	79	76	74	72	70	69	68	
7	88	80	75	71	87	80	75	71	78	74	71	77	73	70	76	73	70	69	67	66	65	
8	85	77	71	68	84	76	71	68	75	71	67	74	70	67	73	70	67	66	64	63	62	
9	82	73	68	65	81	73	68	65	72	67	64	71	67	64	70	67	64	63	61	60	59	
10	79	70	65	62	78	70	65	62	69	65	62	68	64	61	68	64	61	60	58	57	56	55



4"

Architectural LED Downlight

EPD-4

Edison Series

EPD-4-3000L-40K-90-ND-DIM10-MVOLT-EPD-4-401-F-CL-WH

TEST NO: **EPL05022201**

INPUT WATTS: **32.1**

LUMENS: **3181**

EFFICACY: **99**

BEAM ANGLE: **31**

SPACING CRITERIA: **0.48**

CANDELA DISTRIBUTION

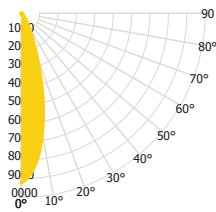

CANDELA TABLE

	0°	90°
0°	9196	9196
10°	6567	6688
20°	2387	2402
30°	702	665
40°	185	201
50°	31	36
60°	3	3
70°	1	1
80°	0	0
90°	0	0

LUMINANCE (cd/sq.m)

	0.00°	90.00°
0.00°	196917	196917
45.00°	2395	2596
55.00°	225	242
65.00°	82	89
75.00°	49	54
85.00°	10	15

LUMENS PER ZONE

ZONE	LUMENS
0° - 10°	771
10° - 20°	1328
20° - 30°	694
30° - 40°	281
40° - 50°	90
50° - 60°	14
60° - 70°	2
70° - 80°	1
80° - 90°	0

ZONAL LUMEN SUMMARY

ZONE	LUMENS	% LUMINAIRE
0° - 20°	2099	66%
0° - 30°	2792	88%
0° - 40°	3073	97%
0° - 60°	3176	100%
0° - 80°	3179	100%
0° - 90°	3179	100%

CONE OF LIGHT

MOUNTING HEIGHT	FC AT BEAM CENTER	BEAM DIA. 0°-180°	BEAM DIA. 90°-270°
6.0 ft	255.4 fc	3.4 ft	3.4 ft
8.0 ft	143.7 fc	4.5 ft	4.5 ft
10.0 ft	92.0 fc	5.6 ft	5.6 ft
12.0 ft	63.9 fc	6.7 ft	6.7 ft
14.0 ft	46.9 fc	7.9 ft	7.9 ft
16.0 ft	35.9 fc	9.0 ft	9.0 ft
18.0 ft	28.4 fc	10.1 ft	10.1 ft
20.0 ft	23.0 fc	11.2 ft	11.2 ft

INDOOR COEFFICIENTS OF UTILIZATION

pf	20%																0%	
	80%				70%				50%				30%					10%
pc	70%	50%	30%	10%	70%	50%	30%	10%	50%	30%	10%	50%	30%	10%	50%	30%	10%	0%
0	119	119	119	119	116	116	116	116	111	111	111	106	106	106	102	102	102	100
1	114	112	110	108	112	110	108	106	106	104	103	102	101	100	99	98	97	95
2	110	106	103	100	108	104	101	99	101	99	97	98	96	95	96	94	93	91
3	106	101	96	93	104	99	95	92	97	94	91	94	92	90	92	90	88	87
4	102	96	91	88	100	95	90	87	93	89	86	91	88	85	89	86	84	83
5	98	91	87	83	97	90	86	83	89	85	82	87	84	81	86	83	81	79
6	94	87	83	79	93	87	82	79	85	81	78	84	80	78	83	80	77	76
7	91	84	79	75	90	83	79	75	82	78	75	81	77	75	80	77	74	73
8	88	80	76	72	87	80	75	72	79	75	72	78	74	72	77	74	71	70
9	85	77	73	69	84	77	72	69	76	72	69	75	72	69	74	71	69	68
10	82	74	70	67	81	74	70	67	73	69	66	73	69	66	72	69	66	65

EPD-4-3000L-40K-90-MD-DIM10-MVOLT-EPD-4-401-F-CL-WH

TEST NO: **EPL05022201**

INPUT WATTS: **32.1**

LUMENS: **3074**

EFFICACY: **96**

BEAM ANGLE: **37**

SPACING CRITERIA: **0.57**

CANDELA DISTRIBUTION

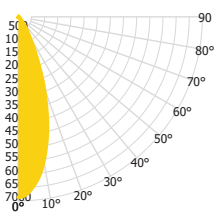

CANDELA TABLE

	0°	90°
0°	6865	6865
10°	5563	5499
20°	2816	2708
30°	777	740
40°	208	220
50°	32	36
60°	3	4
70°	1	1
80°	0	0
90°	0	0

LUMINANCE (cd/sq.m)

	0.00°	90.00°
0.00°	147009	147009
45.00°	2646	2904
55.00°	255	274
65.00°	98	106
75.00°	57	63
85.00°	10	15

LUMENS PER ZONE

ZONE	LUMENS
0° - 10°	604
10° - 20°	1224
20° - 30°	817
30° - 40°	313
40° - 50°	98
50° - 60°	14
60° - 70°	2
70° - 80°	1
80° - 90°	0

ZONAL LUMEN SUMMARY

ZONE	LUMENS	% LUMINAIRE
0° - 20°	1828	59%
0° - 30°	2645	86%
0° - 40°	2958	96%
0° - 60°	3069	100%
0° - 80°	3072	100%
0° - 90°	3073	100%

CONE OF LIGHT

MOUNTING HEIGHT	FC AT BEAM CENTER	BEAM DIA. 0°-180°	BEAM DIA. 90°-270°
6.0 ft	190.7 fc	4.0 ft	4.0 ft
8.0 ft	107.3 fc	5.4 ft	5.4 ft
10.0 ft	68.7 fc	6.7 ft	6.7 ft
12.0 ft	47.7 fc	8.1 ft	8.1 ft
14.0 ft	35.0 fc	9.4 ft	9.4 ft
16.0 ft	26.8 fc	10.8 ft	10.8 ft
18.0 ft	21.2 fc	12.1 ft	12.1 ft
20.0 ft	17.2 fc	13.5 ft	13.4 ft

INDOOR COEFFICIENTS OF UTILIZATION

pf	20%																0%	
	80%				70%				50%				30%					10%
pc	70%	50%	30%	10%	70%	50%	30%	10%	50%	30%	10%	50%	30%	10%	50%	30%	10%	0%
0	119	119	119	119	116	116	116	116	111	111	111	106	106	106	102	102	102	100
1	114	112	110	108	112	110	108	106	106	104	103	102	101	100	99	98	97	95
2	110	105	102	99	107	104	101	98	100	98	96	98	95	94	95	93	92	90
3	105	100	95	92	103	98	94	91	96	92	90	93	91	88	91	89	87	86
4	101	94	90	86	99	93	89	86	91	88	85	89	86	84	88	85	83	81
5	97	90	85	81	95	89	84	81	87	83	80	86	82	79	84	81	79	77
6	93	85	80	77	92	85	80	77	83	79	76	82	78	76	81	78	75	74
7	89	82	76	73	88	81	76	73	80	75	72	79	75	72	78	74	72	70
8	86	78	73	69	85	77	73	69	76	72	69	76	72	69	75	71	69	67
9	83	75	70	66	82	74	69	66	73	69	66	73	69	66	72	68	66	64
10	80	72	67	63	79	71	67	63	71	66	63	70	66	63	69	66	63	62



4"

Architectural LED Downlight

EPD-4

Edison Series

EPD-4-3000L-40K-90-MWD-DIM10-MVOLT-EPD-4-401-F-CL-WH

TEST NO: EPL05022201

CANDELA DISTRIBUTION

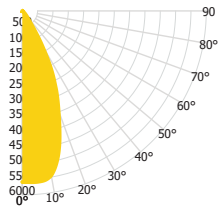

CANDELA TABLE

	0°	90°
0°	5579	5579
10°	5439	5397
20°	3446	3683
30°	1237	1423
40°	215	229
50°	40	48
60°	5	5
70°	2	2
80°	0	1
90°	0	0

LUMINANCE (cd/sq.m)

	0.00°	90.00°
0.00°	477859	477859
45.00°	11776	13161
55.00°	1298	1653
65.00°	608	655
75.00°	374	410
85.00°	69	88

LUMENS PER ZONE

ZONE	LUMENS
0° - 10°	537
10° - 20°	1328
20° - 30°	1180
30° - 40°	410
40° - 50°	100
50° - 60°	17
60° - 70°	4
70° - 80°	2
80° - 90°	0

ZONAL LUMEN SUMMARY

ZONE	LUMENS	% LUMINAIRE
0° - 20°	1865	52%
0° - 30°	3045	85%
0° - 40°	3455	97%
0° - 60°	3572	100%
0° - 80°	3577	100%
0° - 90°	3577	100%

CONE OF LIGHT

MOUNTING HEIGHT	FC AT BEAM CENTER	BEAM DIA. 0°-180°	BEAM DIA. 90°-270°
6.0 ft	155.0 fc	5.3 ft	5.3 ft
8.0 ft	87.2 fc	7.1 ft	7.1 ft
10.0 ft	55.8 fc	8.8 ft	8.8 ft
12.0 ft	38.7 fc	10.6 ft	10.6 ft
14.0 ft	28.5 fc	12.4 ft	12.3 ft
16.0 ft	21.8 fc	14.1 ft	14.1 ft
18.0 ft	17.2 fc	15.9 ft	15.9 ft
20.0 ft	13.9 fc	17.7 ft	17.6 ft

INDOOR COEFFICIENTS OF UTILIZATION

pf	20%																0%				
	80%				70%				50%				30%								
pc	70%	50%	30%	10%	70%	50%	30%	10%	50%	30%	10%	50%	30%	10%	50%	30%	10%	50%	30%	10%	0%
pw	70%	50%	30%	10%	70%	50%	30%	10%	50%	30%	10%	50%	30%	10%	50%	30%	10%	50%	30%	10%	0%
0	119	119	119	119	116	116	116	116	111	111	111	106	106	106	102	102	102	102	102	100	0%
1	114	112	109	107	112	109	107	106	105	104	102	102	100	99	98	97	96	95	95	91	89
2	109	105	101	98	107	103	100	97	100	97	95	97	95	93	94	92	91	89	88	86	84
3	104	99	94	91	103	97	93	90	95	91	89	92	90	87	90	88	86	84	81	80	
4	100	93	88	85	98	92	88	84	90	86	83	88	85	82	86	83	81	80	77	75	
5	96	88	83	79	94	87	82	79	86	81	78	84	80	77	82	79	77	75	72	72	
6	92	84	78	75	90	83	78	74	81	77	74	80	76	73	79	75	73	72	69	68	
7	88	80	74	70	87	79	74	70	78	73	70	77	73	70	75	72	69	68	65	65	
8	84	76	70	67	83	75	70	67	74	70	66	73	69	66	72	69	66	65	63	61	
9	81	72	67	63	80	72	67	63	71	66	63	70	66	63	69	65	63	61	59	59	
10	78	69	64	60	77	68	64	60	68	63	60	67	63	60	66	62	60	59	57	55	

EPD-4-3000L-40K-90-WD-DIM10-MVOLT-EPD-4-401-F-CL-WH

TEST NO: EPL05022201

INPUT WATTS: 32.2

LUMENS: 2791

EFFICACY: 87

BEAM ANGLE: 58

SPACING CRITERIA: 0.84

CANDELA DISTRIBUTION

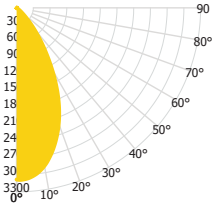

CANDELA TABLE

	0°	90°
0°	3079	3079
10°	2876	2898
20°	2205	2247
30°	1260	1315
40°	459	504
50°	65	80
60°	8	9
70°	3	3
80°	1	1
90°	0	0

LUMINANCE (cd/sq.m)

	0.00°	90.00°
0.00°	65935	65935
45.00°	6347	7185
55.00°	629	682
65.00°	226	247
75.00°	115	125
85.00°	12	12

LUMENS PER ZONE

ZONE	LUMENS
0° - 10°	288
10° - 20°	747
20° - 30°	874
30° - 40°	606
40° - 50°	234
50° - 60°	33
60° - 70°	6
70° - 80°	2
80° - 90°	0

ZONAL LUMEN SUMMARY

ZONE	LUMENS	% LUMINAIRE
0° - 20°	1034	37%
0° - 30°	1908	68%
0° - 40°	2515	90%
0° - 60°	2782	100%
0° - 80°	2790	100%
0° - 90°	2790	100%

CONE OF LIGHT

MOUNTING HEIGHT	FC AT BEAM CENTER	BEAM DIA. 0°-180°	BEAM DIA. 90°-270°
6.0 ft	85.5 fc	6.7 ft	6.6 ft
8.0 ft	48.1 fc	8.9 ft	8.9 ft
10.0 ft	30.8 fc	11.1 ft	11.1 ft
12.0 ft	21.4 fc	13.3 ft	13.3 ft
14.0 ft	15.7 fc	15.5 ft	15.5 ft
16.0 ft	12.0 fc	17.7 ft	17.7 ft
18.0 ft	9.5 fc	20.0 ft	19.9 ft
20.0 ft	7.7 fc	22.2 ft	22.1 ft

INDOOR COEFFICIENTS OF UTILIZATION

pf	20%																0%				
	80%				70%				50%				30%								
pc	70%	50%	30%	10%	70%	50%	30%	10%	50%	30%	10%	50%	30%	10%	50%	30%	10%	50%	30%	10%	0%
pw	70%	50%	30%	10%	70%	50%	30%	10%	50%	30%	10%	50%	30%	10%	50%	30%	10%	50%	30%	10%	0%
0	119	119	119	119	116	116	116	116	111	111	111	106	106	106	102	102	102	102	102	100	0%
1	113	111	108	106	111	108	106	104	104	103	101	101	99	98	97	96	95	93	93	91	89
2	108	103	99	95	105	101	97	94	98	95	92	95	92	90	92	90	88	87	85	83	81
3	102	96	91	87	100	94	90	86	92	88	85	89	86	83	87	84	82	80	78	76	75
4	97	89	84	79	95	88	83	79	86	81	78	84	80	77	82	79	76	75	72	72	
5	92	83	77	73	90	82	77	73	81	76	72	79	75	71	77	74	71	69	67	65	
6	87	78	72	68	86	77	72	67	76	71	67	74	70	66	73	69	66	65	63	61	
7	83	73	67	63	81	73	67	63	71	66	62	70	65	62	69	65	62	60	58	56	
8	79	69	63	59	77	68	63	59	67	62	58	66	61	58	65	61	58	56	54	53	
9	75	65	59	55	74	64	59	55	63	58	55	63	58	54	62	57	54	53	51	50	
10	71	61	55	52	70	61	55	51	60	55	51	59	55	51	59	54	51	50	48	47	



4"

Architectural LED Downlight

EPD-4

Edison Series

EPD-4-3000L-40K-90-VWD-DIM10-MVOLT-EPD-4-401-F-CL-WH

TEST NO: EPL05022201

INPUT WATTS: **32.2** LUMENS: **2628** EFFICACY: **82** BEAM ANGLE: **72** SPACING CRITERIA: **1.09 x 1.09**

CANDELA DISTRIBUTION

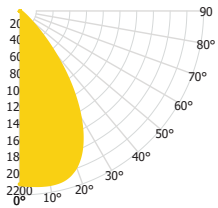

CANDELA TABLE

	0°	90°
0°	2071	2071
10°	2101	2092
20°	1972	1967
30°	1421	1437
40°	590	617
50°	76	85
60°	9	9
70°	3	3
80°	1	1
90°	0	0

LUMINANCE (cd/sq.m)

	0.00°	90.00°
0.00°	44349	44349
45.00°	7851	8507
55.00°	724	750
65.00°	243	258
75.00°	119	130
85.00°	12	22

LUMENS PER ZONE

ZONE	LUMENS
0° - 10°	199
10° - 20°	584
20° - 30°	825
30° - 40°	697
40° - 50°	278
50° - 60°	35
60° - 70°	6
70° - 80°	2
80° - 90°	0

ZONAL LUMEN SUMMARY

ZONE	LUMENS	% LUMINAIRE
0° - 20°	783	30%
0° - 30°	1609	61%
0° - 40°	2306	88%
0° - 60°	2619	100%
0° - 80°	2626	100%
0° - 90°	2627	100%

CONE OF LIGHT

MOUNTING HEIGHT	FC AT BEAM CENTER	BEAM DIA. 0°-180°	BEAM DIA. 90°-270°
6.0 ft	57.5 fc	8.7 ft	8.7 ft
8.0 ft	32.4 fc	11.6 ft	11.6 ft
10.0 ft	20.7 fc	14.5 ft	14.5 ft
12.0 ft	14.4 fc	17.4 ft	17.5 ft
14.0 ft	10.6 fc	20.3 ft	20.4 ft
16.0 ft	8.1 fc	23.2 ft	23.3 ft
18.0 ft	6.4 fc	26.1 ft	26.2 ft
20.0 ft	5.2 fc	29.0 ft	29.1 ft

INDOOR COEFFICIENTS OF UTILIZATION

ρf ρc ρw	20%																0%				
	80%				70%				50%				30%				10%				0%
	70%	50%	30%	10%	70%	50%	30%	10%	50%	30%	10%	50%	30%	10%	50%	30%	10%	50%	30%	10%	0%
0	119	119	119	119	116	116	116	116	111	111	111	106	106	106	102	102	102	102	102	100	0%
1	113	110	108	105	111	108	106	104	104	102	100	100	99	97	97	97	96	96	95	93	0%
2	107	102	98	94	105	100	96	93	97	94	91	94	91	89	91	89	91	89	87	85	0%
3	101	94	89	85	99	93	88	84	90	86	83	88	84	81	85	83	80	78	78	78	0%
4	95	87	81	77	94	86	81	76	84	79	76	82	78	75	80	77	74	72	72	72	0%
5	90	81	75	70	88	80	74	70	78	73	69	77	72	69	75	71	68	66	66	66	0%
6	85	75	69	64	84	75	69	64	73	68	64	72	67	63	70	66	63	61	61	61	0%
7	80	70	64	59	79	70	64	59	68	63	59	67	62	59	66	62	58	57	57	57	0%
8	76	66	59	55	75	65	59	55	64	59	55	63	58	54	62	57	54	53	53	53	0%
9	72	62	55	51	71	61	55	51	60	55	51	59	54	50	58	54	50	49	49	49	0%
10	68	58	52	47	67	57	51	47	57	51	47	56	51	47	55	50	47	46	46	46	0%

