

4"

Architectural LED Downlight - Remodel

EPD-R4

Edison Series

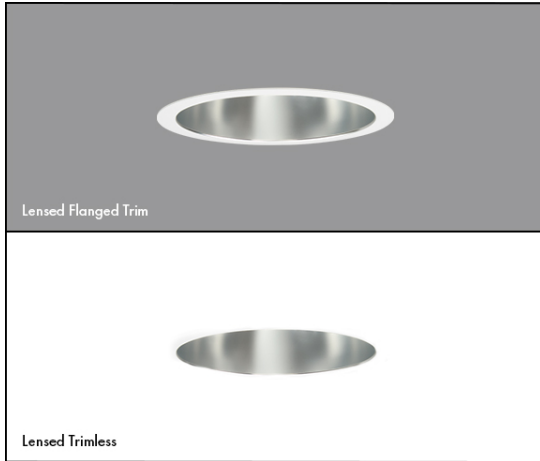

Application

A complete family of downlights, accent lights, wallwashers, double wallwashers, and corner wallwashers in multiple beam spreads and apertures designed for commercial, civic, museums, corporate, hospitality, academic, retail, medical, and houses of worship.

Features

- Exceptional Optical Quality: Up to 98 CRI, 1×2 Step MacAdam Ellipse.
- Shipped standard with a Solite Beam Smoother lens that removes striations from the light source.
- Available with a multitude of dimming protocols and control offerings.

Lumens	900, 1200, 1500, 2000, 3000
CCT & Dynamic Platforms	22K, 27K, 30K, 35K, 40K, 50K Dims to Warm: 30K-18K, 30K-22K or 27K-18K Xicato Artist: 27K, 30K, 35K, 40K, 30K-VIB Natural Spectrum: 27K, 30K, 35K, 40K, 50K, 65K
CRI	90+ Standard, 98+
Color Quality	2 Step MacAdam Ellipse
Distributions	NSPD (15°), SPD (24°), ND (30°), MD (36°), MWD (52°), WD (60°), VWD (70°)
Trim Options	Downlight, Wall Wash, Double Wall Wash, Corner Wall Wash, Wet Location
Reflector Colors	CL (Semi-Specular Chrome), SHZ (Low Iridescent Satin Haze), WT (Wheat), W (White), BK (Black), BZ (Bronze)
Flange Colors	TL (Trimless), WH (Self-Flanged White), SCH (Self-Flanged Semi-Specular Chrome), SHZ (Self-Flanged Low Iridescent Satin Haze), BK (Self-Flanged Black), BZ (Self-Flanged Bronze)
Emergency	EMG-LED-10W, EMG-LED-20W, INTG-EMG-LED-10W, INTG-EMG-LED-20W, EMG-SDT-LED-10W
Lifetime	L70 at 102,000 Hours
Photometric Tests	In Accordance with IES LM79-08, LM80 and TM-30, TM-21



4"

EPD-R4

Edison Series

Architectural LED Downlight - Remodel

PART NUMBER: **EPD-R4-900L-22K-90-NSPD-DIM10-120V**

Series	Lumens	CCT	CRI	Optics	Drivers	Voltage	Emergency	Options
EPD-R4	900L	22K	90+	NSPD	DIM10	120V	-	-
	1200L	27K	98+ 2	SPD	LUTH	277V	EMG-LED-10W	USA
	1500L	30K		ND	LUT2W 3	MVOLT	EMG-LED-20W	
	2000L	35K		MD	LUTFTB 4	347V 5	INTG-EMG-LED-10W	
	3000L	40K		MWD	ELDO10.1		INTG-EMG-LED-20W	
		50K 1		WD	ELDODMX.1		EMG-SDT-LED-10W	
			VWD	ELDODALI.1	DIMTR 3			
					BLE-CASAMBI			

1 50K series are available with 85+ CRI only 2 98+ CRI is available in 27K, 30K and 40K only 3 DIMTR and LUT2W available in 120V only 4 LUTFTB Available for luminaires up to 1500L 5 347V is available in only DIM10

PART NUMBER: **EPD-R4-WDM-30K-18K-900L-90-NSPD-DIM10-120V**

Series	Technology	Lumens	CRI	Optics	Drivers	Voltage	Emergency	Options
EPD-R4 <i>(Dim to Warm)</i>	WDM-30K-18K	900L	90+	NSPD	DIM10	120V	-	-
	WDM-30K-22K	1200L		SPD	LUTH	277V	EMG-LED-10W	USA
	WDM-27K-18K	1500L		ND	LUT2W 1	MVOLT	EMG-LED-20W	
		2000L		MD	LUTFTB 2		INTG-EMG-LED-10W	
				MWD	DIMTR 1		INTG-EMG-LED-20W	
				WD	ELDO10.1		EMG-SDT-LED-10W	
			VWD	ELDODALI.1	ELDODMX.1			
					BLE-CASAMBI			

1 DIMTR and LUT2W available in 120V only 2 LUTFTB Available for luminaires up to 1500L 3 CP Available for luminaires up to 1500L

PART NUMBER: **EPD-R4-XIA-900L-27K-98-NSPD-DIM10-120V**

Series	Technology	Lumens	CCT	CRI	Optics	Drivers	Voltage	Emergency	Options
EPD-R4 <i>(Xicato Artist)</i>	XIA	900L	27K	98+	NSPD	DIM10	120V	-	-
		1200L	30K		SPD	LUTH	277V	EMG-LED-10W	USA
		1500L	30K-VIB		ND	LUT2W 1	MVOLT	EMG-LED-20W	
			35K		MD	LUTFTB 2	347V 3	INTG-EMG-LED-10W	
			40K		MWD	ELDO10.1		INTG-EMG-LED-20W	
					WD	ELDODMX.1		EMG-SDT-LED-10W	
		VWD	ELDODALI.1	DIMTR 1					
					BLE-CASAMBI				

1 DIMTR and LUT2W available in 120V only 2 LUTFTB Available for luminaires up to 1500L 3 347V is available in only DIM10

4"

Architectural LED Downlight - Remodel

EPD-R4

























Edison Series

PART NUMBER: **EPD-R4-NSL-900L-27K-97-NSPD-DIM10-120V**

Series	Technology	Lumens	CCT	CRI	Optics	Drivers	Voltage	Emergency	Options
EPD-R4 <i>(Natural Spectrum)</i>	NSL	900L	27K	97+	NSPD	DIM10	120V	-	-
		1200L	30K		SPD	LUTH	277V	EMG-LED-10W	USA
		1500L	35K		ND	LUT2W ¹	MVOLT	EMG-LED-20W	
		2000L	40K		MD	LUTFTB ²	347V ³	INTG-EMG-LED-10W	
			50K		MWD	ELDO10.1		INTG-EMG-LED-20W	
	65K	WD	ELDODMX.1		EMG-SDT-LED-10W				
			VWD		ELDODALI.1				
					DIMTR ¹				
					BLE-CASAMBI				

¹ DIMTR and LUT2W available in 120V only ² LUTFTB Available for luminaires up to 1500L ³ 347V is available in only DIM10

ORDER GUIDE

REFLECTOR TYPE				MOUNTING	COLOR				
REFLECTOR TYPE				MOUNTING	COLOR				
Open Downlight EPD-4-401	Wall Wash EPD-4-407	Double Wall Wash EPD-4-477	Corner Wall Wash EPD-4-427	Flanged 	ANODIZED FLANGED				
					Clear White CL-WH 	Clear Bronze CL-BZ 	Black White BK-WH 	Satin Haze SHZ-SHZ 	Wheat WT-WT 
					Clear Semi-Spec CL-SCH 	Satin Haze White SHZ-WH 	Black BK-BK 	Satin Haze Black SHZ-BK 	
					Clear Black CL-BK 	White WH-WH 	Bronze BZ-BZ 	Wheat White WT-WH 	
Open Downlight EPD-4-TL-401	Wall Wash EPD-4-TL-407			Trimless 	ANODIZED TRIMLESS				
					White WH 	Black BK 	Clear CL 	Satin Haze SHZ 	



WWW.EPL.COM | 718.685.0700 | NEW YORK / LOS ANGELES

Architectural LED Downlight - Remodel

Modifications Available

Consult factory for modification requests; orders may require shop drawing approval.

Downlight

Our signature anodized reflector, spun to a reverse parabola design, achieves a 50° shielding angle and a 40° cut-off, which eliminates inter-reflections, and enhances low aperture brightness

Wall Wash

The optical assembly delivers uniform ceiling-to-floor wallwashing without creating any visible scallops. The optical assembly is specially designed to extend a beam in two directions for a uniform floor-to-ceiling and side-to-side wash of light.

Double Wall Wash

Used in a corridor to wash both walls, providing both horizontal and vertical illumination that fully illuminates corridors and hallways.

Corner Wall Wash

Replacing the effect that two luminaires provide, a corner wallwasher kicks light across corners that run perpendicular to one another, ultimately providing a 210° wash of light fully covering conjoined walls and surfaces.

Optical Performance and Trim

Spun aluminum anodized single piece reflector. The optical system consists of 1) an upper reflector for a precise beam spread; 2) a solite soft focus lens to diffuse the light source for smooth, striation-free distribution; 3) and a patented lens to control the beam angle and provide a 40° visual cutoff. Available in a variety of beam angles. Integral heatsink comes preinstalled on the housing for maximum heat dissipation and locks together with the reflector to prevent zero light leakage for above the ceiling.

Fully Servicable - Easy Installation & Upgrading

Remodel type housing is designed for fast and easy installation in existing plaster or mechanical ceiling thickness from 1/2" to 1-3/4", with four remodel clips that are easily retractable for luminaire removal, if necessary. Torsion springs on each side of the reflector hold snug to the ceiling, and allows for fast, easy installation into housing, and fast removal for easy access to the junction box from below the ceiling.

Trim Design

Luminaire is designed for installation in sheetrock or T-Bar ceilings to achieve a flush trim detail

Housing / Mounting

16-gauge steel, preassembled one-piece construction, and four preinstalled spring clips which secure the housing firmly into ceiling to accommodate different ceiling thicknesses from 1/2" to 1-3/8."

Emergency Options/Controls

The test switch for the emergency battery can be installed on the side of the reflector (integral INTG-EMG option), or the test switch can be mounted remotely (EMG-LED option). Self Diagnostic emergency option available (EMG-SDT-LED-10W) Typical lumen output of the luminaire is up to 1000L with EMG-LED-10W or INTG-EMG-LED-10W option & 2000L with EMG-LED-20W or INTG-EMG-LED-20W option in emergency mode. Other accessories and controls systems include modular wiring systems, daylight harvesting controls, occupancy sensors, and/or power packs for individual or room control applications.

Driver

120/277V 50/60Hz; 347V available. THD < 20%; power factor >.09. Thermally protected. Removal of the reflector provides complete accessibility to the junction box, driver and internal components from above and below the ceiling through the aperture.

Dim to Warm Option

Dims to Warm simulates traditional incandescent halogen lighting through dimming. When the luminaire dims to warm from 100% to .1%, it makes a smooth transition across the black body radiator while maintaining a constant CRI of 90+. Available in 30K-18K, 30K-22K or 27K-18K range.

Xicato Artist Series LED Module (XIA)

Powered by Xicato Artist Series®, which are tested to IES TM-30-15, with a color fidelity score (Rf) of 96 and a color gamut score (Rg) of 102, and color shift less than du'v' of 0.003. Featuring cold phosphor technology, improving thermal management enhancing color consistency and delaying lumen depreciation.

Natural Spectrum (NSL)

Natural Spectrum LED option is designed for Human Centric lighting application. Natural Spectrum LEDs diminish blue light peak, similar spectral curve to sunlight, accurate rendering of colors and reduced scattered reflection and glare.

Dimming & Driver Information

DIM10 - 0-10V dimming on either MVOLT 120, 277 or 347V. Dimmable down to 1% of initial lumens, standard

LUTH - Lutron LDE1 Hi-Lume Eco System with Soft Fade to Black 1% dimming

LUT2W - Lutron LTEA2W Hi-Lume 1%. 2-wire LED Driver Forward Phase 120V only

LUTFTB - Lutron PEQ0 Hi-Lume Premier Eco System LED Driver with soft-on fade to black 0.1% dimming

ELDO10.1 - EldoLED SoloDrive 0-10V. Dimming down to 0.1%

ELDODMX.1 - EldoLED PowerDrive dimming down to 0.1%. Please see EldoLED website for wiring diagrams and a list of compatible DMX and DALI control systems.

ELDODALI.1 - EldoLED SoloDrive DALI-2. Dimming down to 0.1%

DIMTR - Triac & Electronic low voltage forward phase dimming. Available in 120V only

BLE-CASAMBI - Luminaires may be controlled, grouped, scheduled or placed in scenes, and or zones Via Cassambi Bluetooth 4.0 App."



4"

Architectural LED Downlight - Remodel

EPD-R4

Edison Series

FLANGED

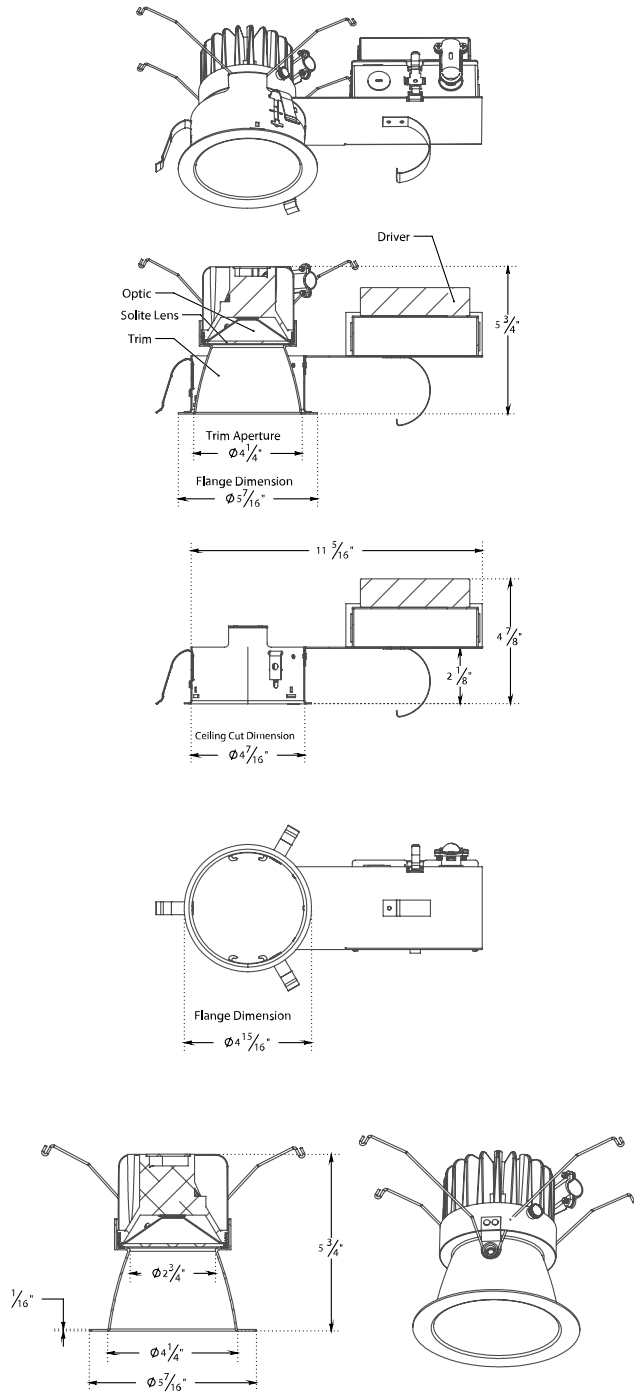

WWW.EPL.COM | 718.685.0700 | NEW YORK / LOS ANGELES