

FINO (-SRF)

One-Inch Linear Slot



Slim, Direct, and Purpose-Built

Our narrow linear fixtures bring definition to contemporary interiors. With edges that disappear into the architecture and a continuous ribbon of light, they trace walls, ceilings, and millwork without distraction. Each model is built to install cleanly, deliver even light from end to end, and adapt to spaces where precision is essential — whether framing a corridor, outlining a display, or marking a path.



INTRODUCTION

A versatile, ultra-slim linear lighting system combining sleek aesthetics with high-performance illumination. Perfect for modern architectural applications, this product line offers flexible design options, seamless integration, and exceptional lighting quality.

APPLICATIONS

The FINO system is ideal for applications requiring high-performance linear lighting, including retail, hospitality, and commercial interiors. Its ability to achieve seamless continuous runs up to 60 feet offers unique opportunities for bold and expansive lighting designs.

FEATURES

Profile

The FINO system is built with an ultra-slim 1" (25mm) extruded aluminum housing, engineered for lightweight durability and precise architectural integration. Its minimalist profile is designed to complement modern spaces without interrupting the aesthetic flow.

Optical Precision

FINO features advanced optical solutions, including high-quality polycarbonate lenses for uniform light diffusion and a newly developed flexible silicone lens. This innovative silicone lens allows for continuous row mounting up to 60 feet, delivering seamless illumination without visual breaks.

Custom Lengths

The system is manufactured to exact specifications, accommodating lengths from 4" to 96" (100mm to 2.4m) for standard fixtures, with the silicone lens enabling extended continuous runs, ideal for large-scale installations.

Dimming Compatibility

Engineered to integrate with leading dimming technologies, FINO supports 0-10V, DALI, and CASAMBI protocols. This compatibility ensures precise lighting control, from ambient dimming to high-output task lighting.

Installation

FINO is designed for efficient installation, featuring modular components, precision mounting hardware, and alignment guides. The flexible silicone lens simplifies continuous row mounting, reducing the need for multiple joins and ensuring a clean, uninterrupted installation.

Durability

Constructed from extruded aluminum with a durable finish and paired with high-performance LEDs, FINO is designed for longevity. The polycarbonate and silicone lenses are engineered for resilience, maintaining clarity and flexibility in demanding environments.

SPECIFICATIONS

EFFICIENCY: 120LM/W

Configuration	Lumens/ft	W/ft	Distributions
Suspended Direct	Up to 630	6.11	Diffuser, Microprismatic, 30° Multi-Wownlight, 60°
Suspended Direct/Indirect	Up to 690 indir. Up to 690 direct	6.06	Multi-Downlight, Asymmetric, Double
Recessed	Up to 630	6.07	Asymmetric, Block Diffuse, Blind Cover
Surface-Mount	Up to 630	6.11	

OPTICS DISTRIBUTIONS

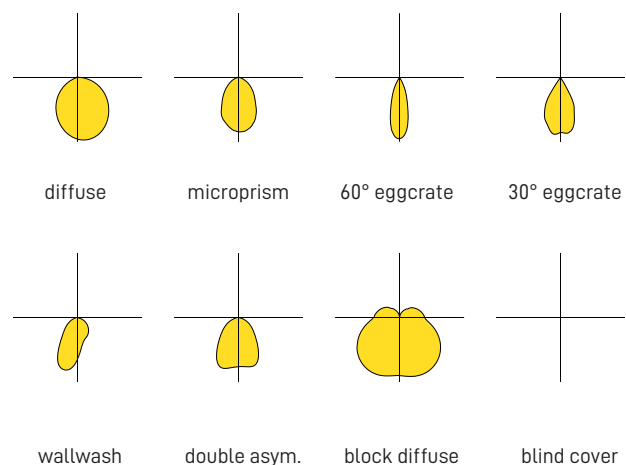

LISTINGS



ORDERING GUIDE

Example: FINO-SRF-FLEX-27-90-WH-08-DIM10-MVOLT-SS

FAMILY -	LENS/OPTIC -	CCT -	CRI -	FINISH -	LENGTH / SHAPE -
FINO-SRF Fino Direct Surface Mount	FLEX Flexible Silicone Lens (Diffuse) (<60'/roll)	27 2700K	90 90+ CRI	WH White Finish	02 2'-0" Length
	PR Prismatic	30 3000K		BK Black Finish	04 4'-0" Length
	AS Asymmetric	35 3500K		CUST Custom Finish (RAL)	06 6'-0" Length
	DAS Double Asymmetric	40 4000K			08 8'-0" Length
	SG Soft Glow Drop Lens	50 5000K			CUST* Custom Length / Shape; *Consult Factory
	BL Blind Lens	TWH* 2700K-6500K *Consult factory for availability			<i>Standard Layouts shown on next page ></i>
	G30¹ Grating 30°				21 21-5/8" Length
	G60¹ Grating 60°				44 43-5/16" Length
	¹ Grating uses custom rigid 538 mm (21-3/16") LED boards, with cutting units at 4-3/16"				63 63" Length
					87 86-5/8" Length
					CUST* Custom Length / Shape; *Consult Factory

DRIVERS ² -	VOLTAGE ³ -
DIM10 (Blank) 0-10V, 1%	MVOLT 120-277V
DALI* *Consult factory for availability	³ Luminaire input voltage fixed at 24VDC; Remote driver input is multi-volt with a dedicated 24V output to luminaire
CASAMBI* *Consult factory for availability	
² Remote drivers with proprietary cable gripper canopy system	

STANDARD PATTERNS (WITH RIGHT ANGLES)

Example: FINO-SRF-DF-27-90-WH-CUS-L-4'X8'-DIM10-MVOLT-SS

L Pattern with XY Length

Example: L-4'x8'

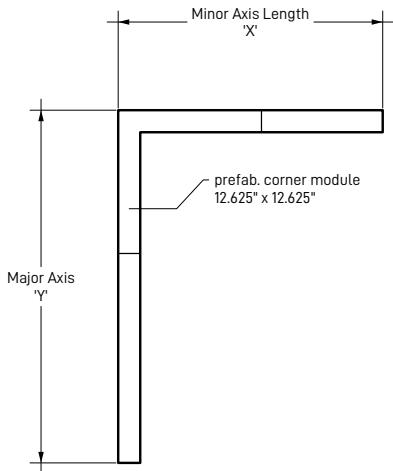

L Pattern with XY Length

Example: L-8'x4'

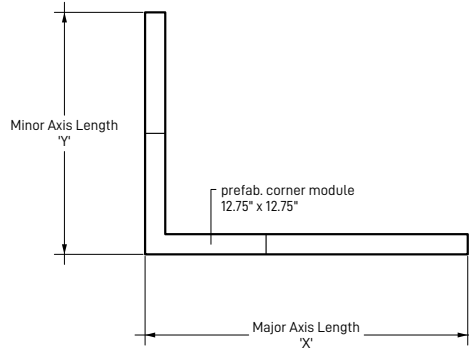

Rectangular (Square) Pattern with XY Length

Example: REC-4'x8'

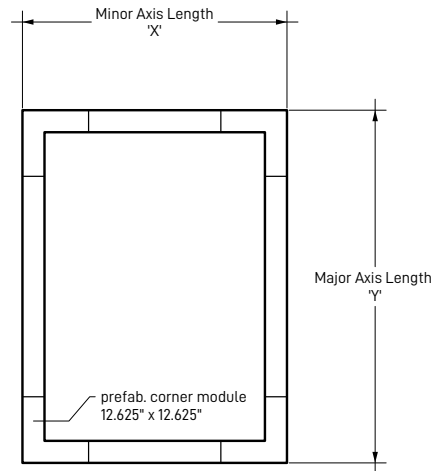

T Pattern with XY Length

Example: T-4'x8'

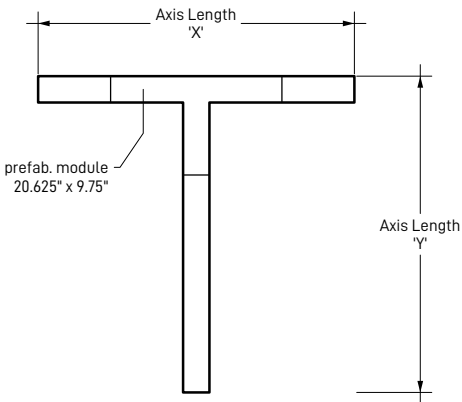

U Pattern with XYZ Length

Example: U-2'x4'x8'

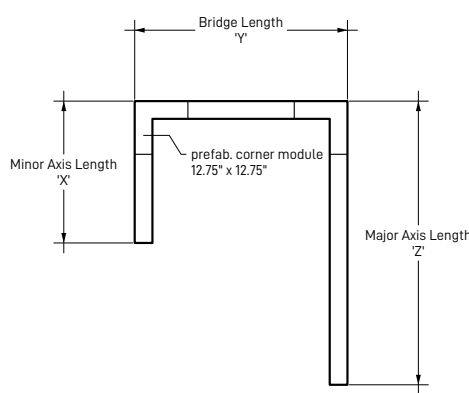

X Pattern with XY Length

Example: X-4'x4'

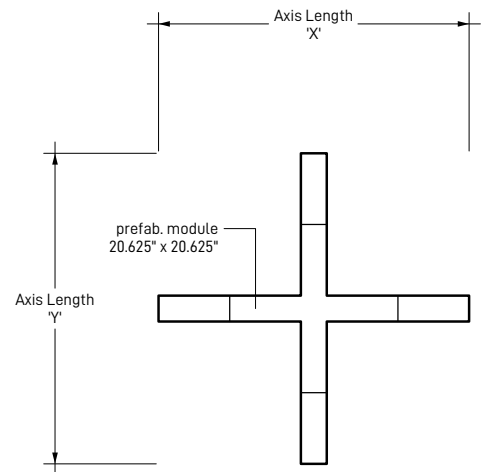

General Notes:

All corner modules are prefabricated, but can be altered in factory upon request. We will assume units are in feet unless specified otherwise.

Consult application engineering for custom layouts now shown here.

CORNER CONDITIONS -

T-Corner

Standalone luminaire, or custom layout

L-Corner

Standalone luminaire, or custom layout

X-Corner

Standalone luminaire, or custom layout

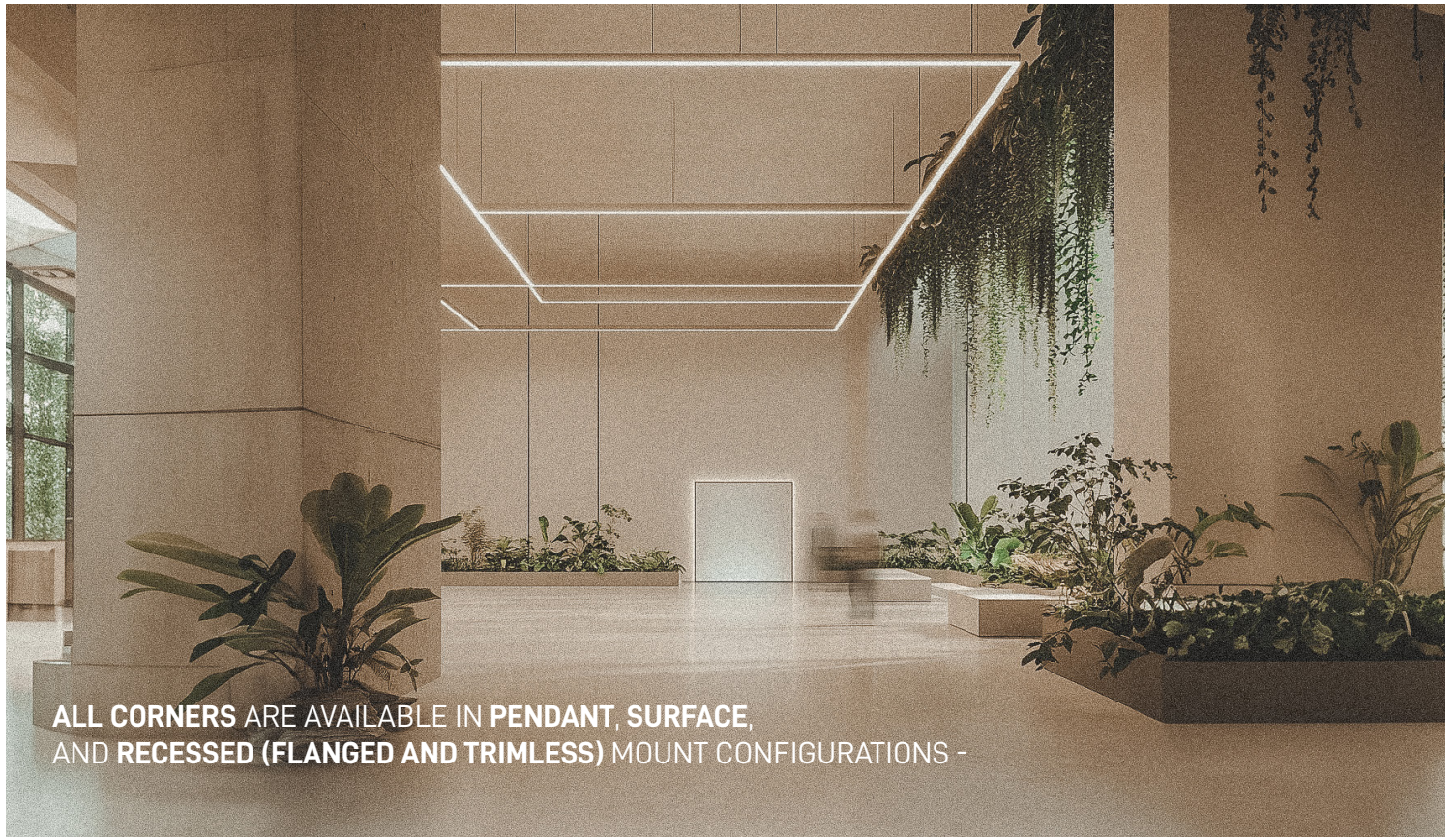
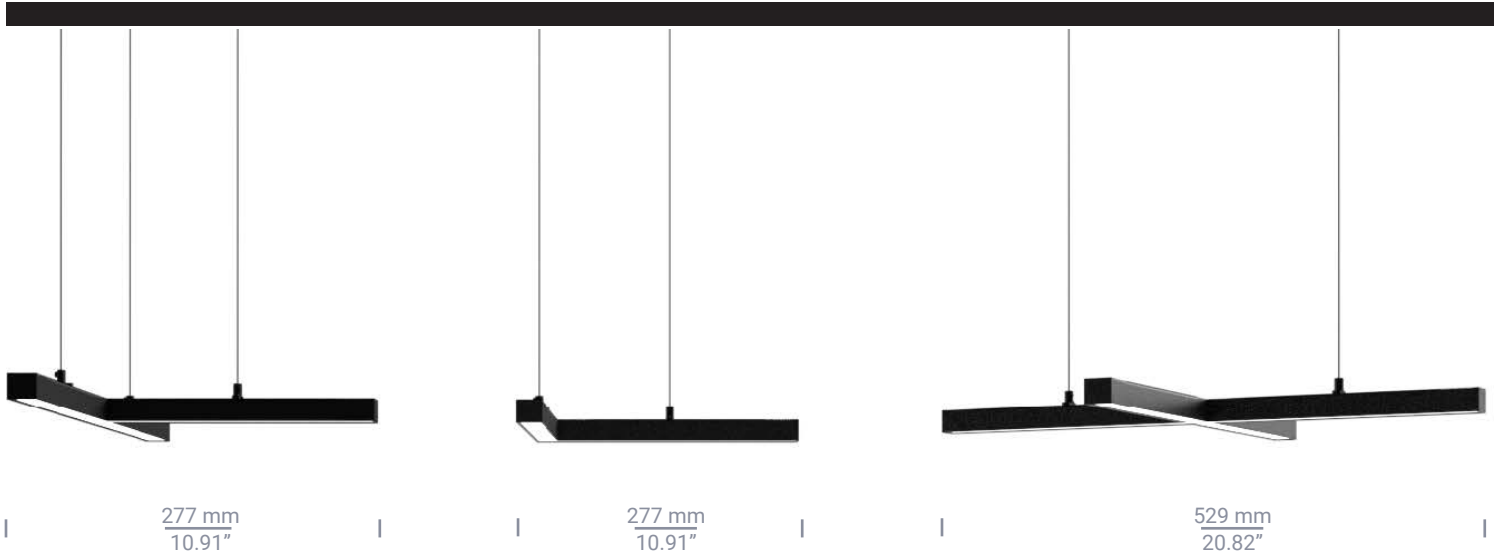

**ALL CORNERS ARE AVAILABLE IN PENDANT, SURFACE,
AND RECESSED (FLANGED AND TRIMLESS) MOUNT CONFIGURATIONS -**

FAMILY (OF PROFILES)

FINO-SRF (Fino Direct Surface Mount)

Surface-mounted for under-cabinet and low-ceiling use.

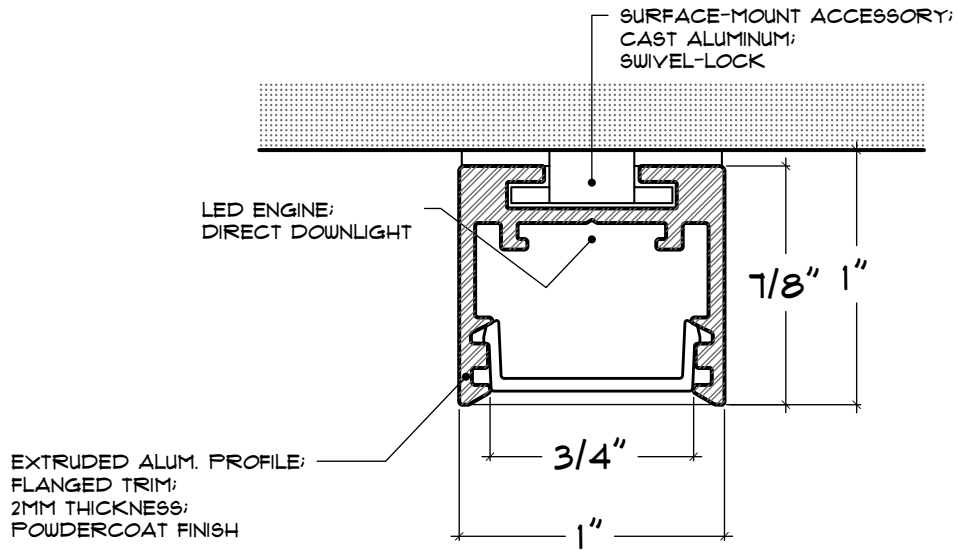

FINO-SRF ONE-INCH LINEAR (SURFACE-MOUNT)

Edison Price Lighting Linear Portfolio



IN APPLICATION

The FINO mounting options include Pendant for suspended lighting, Surface for low-profile installations, Wall for vertical illumination, Recessed Flanged for clean installs with visible edges, and Recessed Trimless for seamless, concealed designs.



LENS/OPTICS -

FLEX (Flexible Silicone Diffuser)

A versatile option for uniform, general lighting in offices, retail spaces, and corridors. It delivers clean, even light, making it a reliable choice for a wide range of applications.

Flexible silicone lens in rolls up to 66 feet [20m]



AS (Asymmetric)

Provides directional light for wall washing or accentuating architectural features. This lens is ideal for highlighting textures, art, or signage with precision.



PR (Prismatic)

Best for reducing glare while maintaining high performance, perfect for offices and task-focused environments. The micro-prismatic surface ensures superior visual comfort in spaces where precision is key.



DAS (Double Asymmetric)

Designed for aisle lighting, shelving displays, and retail environments requiring balanced light distribution. It provides dual directional beams for even illumination across wide spaces.



SG (Soft Glow)

Adds a decorative touch with soft, glare-free illumination for hospitality and residential applications. The slightly protruding design enhances aesthetics while maintaining functionality.

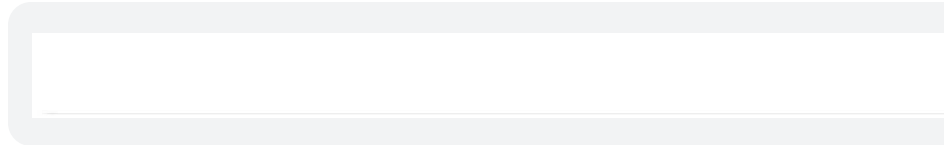

BL (Blackout)

Used to cover unused sections in continuous runs for a clean, finished appearance. It ensures the fixture retains a cohesive look even in non-illuminated areas.

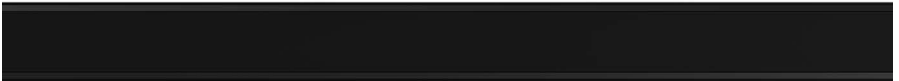

G30 (Micro-Optics 30°) & G60 (Micro-Optics 60°)

Gratings provide precise directional control with options for 30° or 60° beam angles, tailored to task or accent lighting needs. These options are ideal for creating focused illumination or blending light in open spaces, using custom rigid LED boards for maximum flexibility.

***Has specific cutting lengths independent of product line.
Please consult factory for custom finished lengths.**



FLEX (Flexible Silicone Diffuser)

Our silicone diffuser offers 65 feet [20 meters] of uninterrupted, glare-free illumination in a slim, streamlined design. Ideal for straight runs in interior spaces, it delivers smooth, consistent lighting with no hotspots or distractions. Designed for precision and simplicity, it's the go-to solution for modern, refined lighting projects.



LENS/OPTICS -

FLEX (Flexible Silicone Diffuser)

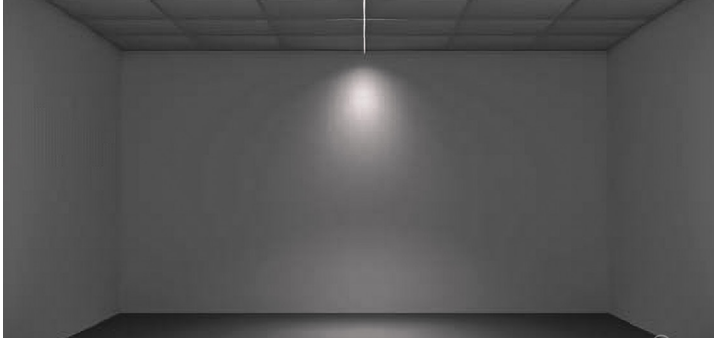

SG (Soft Glow)

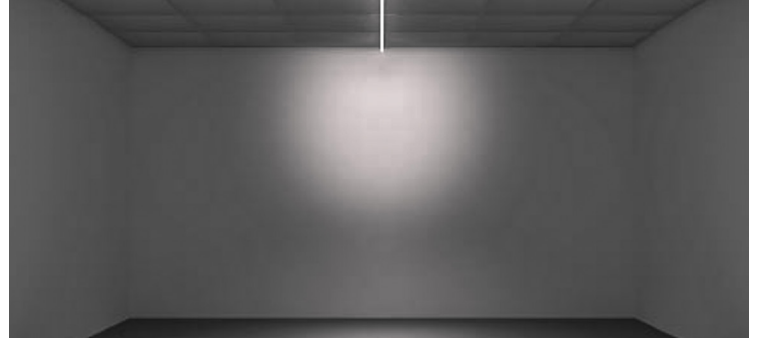

PR (Prismatic)

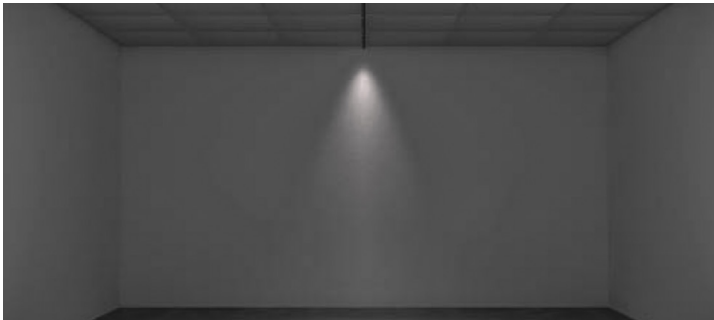

AS (Asymmetric)

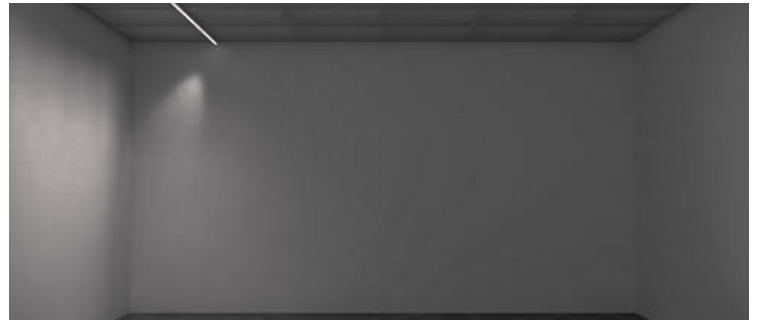

DAS (Double Asymmetric)



BL (Blackout)



G30 (Micro-Optics 30°) & G60 (Micro-Optics 60°)

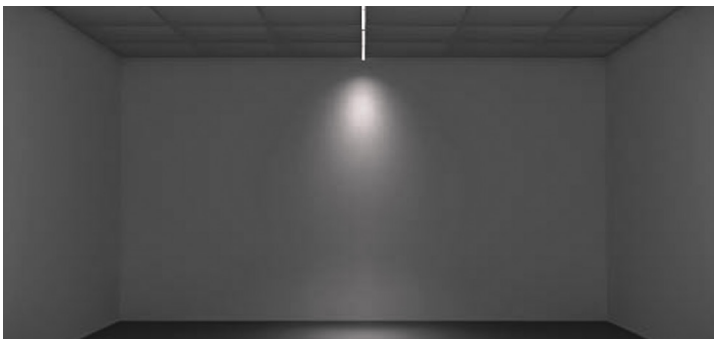

G30 (Micro-Optics 30°) & G60 (Micro-Optics 60°)

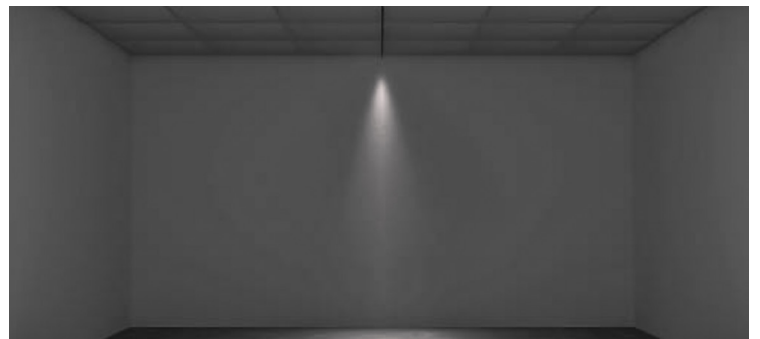

FINISHES -

WH (White Powdercoated)

Trimless recessed for seamless, modern integration.



BK (Black Powdercoated)

Trimless recessed for seamless, modern integration.



CUST (Custom RAL Powdercoated)

Consult factory for custom RAL-matched powdercoated finishes

ACCESSORIES DIAGRAM - Common Installation Types

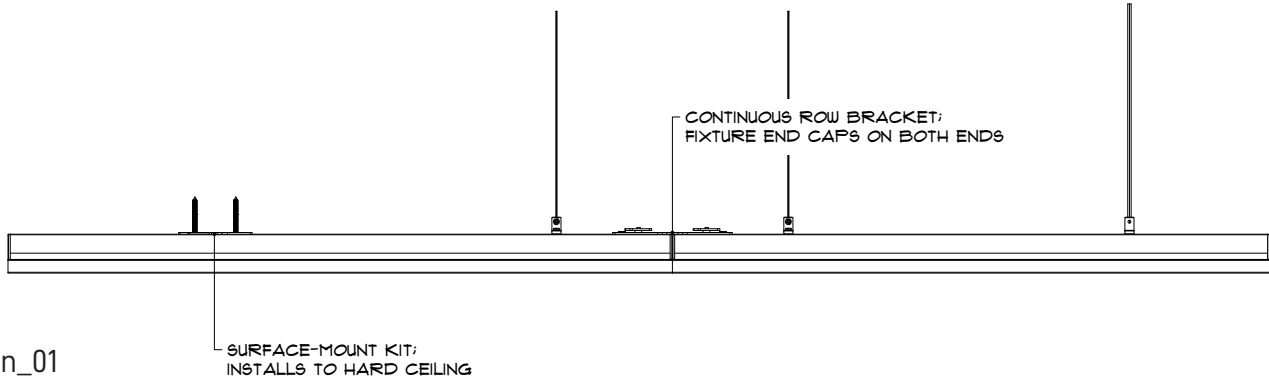

elevation_01

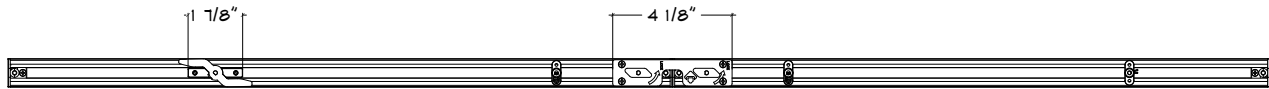

plan_01

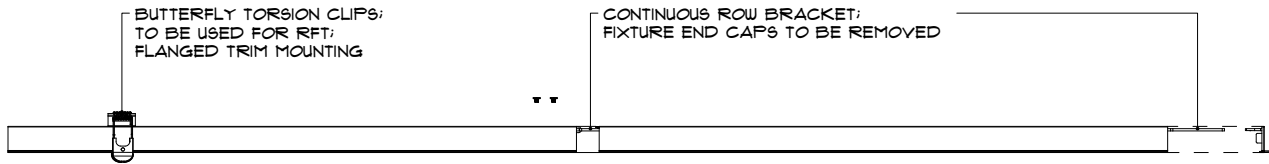

elevation_02



plan_02

0-10V DIM10 (Standard) Remote Driver Selection -

When using remote drivers for LED systems, it's crucial to provide sufficient current for the LEDs to operate without issues such as flickering, dimming, or color shifts. The distance between the driver and the fixture plays a key role in the performance of the system. To prevent these problems, the correct wire gauge must be chosen based on the required distance between the driver and the fixture.

For optimal performance, a voltage drop of up to 3-4% is typically acceptable.

(Total linear feet x 6.10 W/ft)

Calculate the Total Power Consumption

Begin by calculating the total wattage of your LED system.

If the wattage is not an exact round number, round up to the nearest 10 watts for simplicity.

0.80 (headroom)

Maximum Cable Length from Driver to Fixture												
24V DC Driver												
Wire Gauge	Total Fixture Wattage											
	10W	20W	30W	40W	50W	60W	70W	80W	90W	100W	200W	300W
18 AWG	134' (40.8m)	68' (20.7m)	45' (20.7m)	33' (10.1m)	27' (8.2m)	22' (6.7m)	19' (5.8m)	17' (5.2m)	15' (4.5m)	14' (4.3m)	7' (2.1m)	5' (1.5m)
16 AWG	215' (65.5m)	109' (33.2m)	72' (22.0m)	54' (16.5m)	43' (13.1m)	36' (11.0m)	31' (9.5m)	27' (8.2m)	24' (7.3m)	22' (6.7m)	11' (3.4m)	7' (2.1m)
14 AWG	345' (105.2m)	174' (53.0m)	115' (35.1m)	86' (26.2m)	69' (21.0m)	57' (17.4m)	49' (14.9m)	43' (13.1m)	39' (11.9m)	36' (10.9m)	17' (5.2m)	12' (3.7m)
12 AWG	539' (164.3m)	272' (82.9m)	181' (55.2m)	135' (41.2m)	108' (32.9m)	90' (27.5m)	77' (23.5m)	68' (20.7m)	62' (18.9m)	56' (17.1m)	27' (8.2m)	18' (5.5m)
10 AWG	784' (239.0m)	397' (121.0m)	263' (80.2m)	197' (60.1m)	158' (48.2m)	131' (39.9m)	112' (34.1m)	98' (29.9m)	95' (28.9m)	82' (25.0m)	43' (13.1m)	29' (8.8m)

DETERMINE THE RIGHT DRIVER BASED ON LENGTH (Total linear feet x ~6.10 W/ft, then add ~20% headroom)

Example: HLG-120H-24B

MODEL-	OUTPUT POWER-	OUTPUT VOLTAGE OPTIONS-	TYPICAL APPLICATIONS
HLG-40H-24B	40W	12V-54V	Short rope light runs, accent lighting
HLG-60H-24B	60W	12V-54V	Small installations, under-cabinet lights
HLG-100H-24B	100W	12V-54V	Medium-length rope lights
HLG-120H-24B	120W	12V-54V	Standard installations
HLG-150H-24B	150W	12V-54V	Extended runs
HLG-185H-24B	185W	12V-54V	Longer installations
HLG-240H-24B	240W	12V-54V	High-power applications
HLG-320H-24B	320W	12V-54V	Large-scale projects
HLG-480H-24B	480W	12V-54V	Very long rope light runs
HLG-600H-24B	600W	12V-54V	Extensive installations

Note: Note: For optimal performance and extended driver lifespan, it is recommended that the total load not exceed 80% of the LED driver's rated capacity. Operating at or near maximum capacity may reduce efficiency and shorten the service life of the driver.