

Project

Type



Date Product Code

Designer

IDM ARTIMA®/5 HI O

track mounted LED accent light with integral dimmer

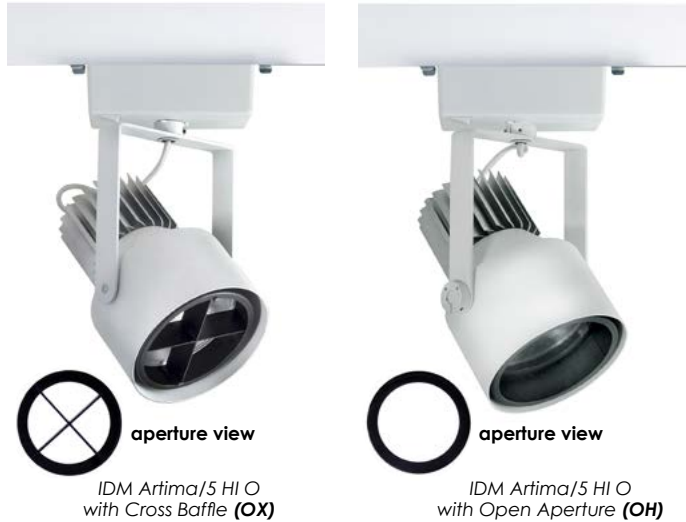

- Luminaire may be configured to mount to any of eighteen 20-amp, 120-volt [track systems](#) – or – to any of six 277-volt track systems.
- Whether operated on 120-volt or 277-volt track, luminaire may be dimmed to 10% by an integral rotary dimmer located on one side of the driver case. Dimmer control shaft is spring loaded, permitting shaft to be exposed for adjustment and then depressed flush with the driver case to conserve dimmer setting. ‘Clock face’ markings permit registration of dimmer setting. (See illustrations below.)
- Bluetooth controls and integral rotary dimmer can be specified together in the same fixture. Users can dim by the protocol of their choice, switching between the two options as desired.
- An on-off rocker switch, mounted in the driver case, is included standard on luminaires equipped for 120-volt track only.
- Fixture function can be changed with your choice of Aperture Assembly and your choice of ‘twist and lock’ reflector.
- Aperture Assembly/Reflector choices
 - Cross Baffle (OX) for enhanced glare control; for use with interchangeable 15°, 21° and 38° reflectors.
 - Open Aperture (OH) for maximum efficacy; for use with interchangeable 15°, 21° and 38° reflectors.
- Fixture is provided with a single Aperture Assembly and a single reflector. Additional reflectors may be ordered as accessories.
- **Optical Accessories:** Both OX and OH Aperture Assemblies accept one or two of a number of spread lenses or color filters. With the OX assembly lens orientation may be adjusted by rotating the cross baffle. A complimentary beam smoother is included with either assembly.
- Luminaire provides 385° horizontal rotation and vertical adjustment from 0° to 90°. Lamp focus can be locked by tightening two collar clamps using a 9/64" hex key.
- For more information, [click here](#).

For the outlet box mounted version of luminaire, see [IDM Artima/5 HI O-OBM](#).

IDM Artima/5 HI O is a track mounted accent light powered by Citizen chip-on-board LED's providing either a CRI of 97 within 2-step MacAdam ellipses or a CRI of 80 within 3-step MacAdam ellipses. See tables on the reverse for wattages and efficiencies.

PRODUCT CODE

For complete product code, list basic unit and select one item from each following box.

Basic Unit IDM-A5-CZL2

Track Configuration

120-volt track (e.g. SightLine) 2C
277-volt track (e.g. HighLine) no switch; not dimmable HC

Finish

white: white paint, white lead cord, matte aluminum heat sink; white switch - WH
black: black paint, black lead cord, black heat sink; black switch - BL
Industrial Silver: silver paint, black lead cord, black heat sink; black switch - SI
custom color: include paint number or physical chip with order and select one from below
• white lead cord, matte aluminum heat sink; white switch - CCW
• black lead cord, black heat sink; black switch - CCB
• any other combinations require a special order

Aperture Assembly

Cross Baffle - OX
Open Aperture - OH

Beam Spread Reflector (specify one to ship with fixture)

15° spot - 15D
21° narrow flood - 21D
38° flood - 38D

Light Source Output (Lumens)

4300L / CRI 97 2700K, 3000K & 4000K only - L43A
5600L / CRI 80 all light colors - L56S

Light Color

2700 K - 27K
3000 K - 30K
3500 K not available with all Light Outputs (see above) - 35K
4000 K not available with all Light Outputs (see above) - 40K
5000 K not available with all Light Outputs (see above) - 50K

Dimming Notes:

- Fixture may be dimmed only by its integral dimmer.
- Fixture cannot be dimmed by a dimmer of any kind on the track circuit.
- Fixture may be damaged by use of an incandescent or ELV dimmer on the track circuit.
- Fixture will not be dimmed or damaged by use of a 0-10V dimmer on the track circuit.
- Combination with wireless Bluetooth controls available on [Bluetooth](#) model.

EXTRA APERTURES & REFLECTORS

Specify as separate line items.

Aperture Assembly

Cross Baffle RK-A5-CZ-OX
Open Aperture RK-A5-CZ-OH

15° spot reflector CZL-REF15
21° narrow flood reflector CZL-REF21
38° flood reflector CZL-REF38



DIMMER OPERATION

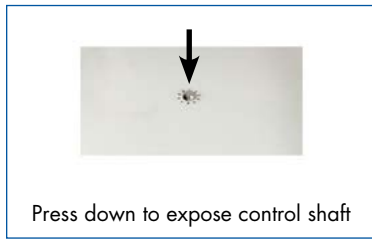

OPTICAL ACCESSORIES

Specify as separate line items.
All are 4 3/4" (121 mm) diameter. Lenses and filters are glass; screens are aluminum.

- 30° spread lens LENS/4.75-30
- 20° x 55° spread lens LENS/4.75
- 70° spread lens LENS/4.75-70
- prismatic lens (Solite) PLS/4.75
- 40° x 70° spread lens LENS/4.75-4070
- beam smoother CLR/4.75
- color filters**
- Daylight Blue DAY/4.75
- Surprise Pink PNK/4.75
- amber AMB/4.75
- blue BLU/4.75
- green GRN/4.75
- red RED/4.75
- 33% light reduction screen SCR33/4.75
- 50% light reduction screen SCR50/4.75

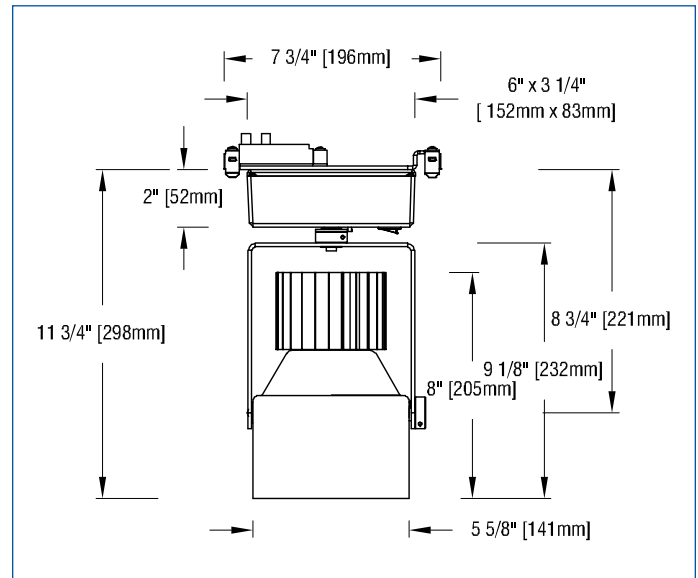

BARN DOORS

Specify as separate line items.
Specify with one optical accessory (not included), see above.

- white BD-A5-WH
- black BD-A5-BL
- silver BD-A5-SI
- custom color BD-A5-CC



APPLICATIONS

Luminaire is suitable for highlighting vertical or horizontal surfaces, as well as objects in museums, galleries, showrooms, residences, offices and stores.

Luminaire is listed for mounting on Edison Price Lighting 120-volt or 277-volt track.

Fixture Spacing Requirements The track adapter of this fixture is 7 3/4" long. For this reason 1) it cannot be track-mounted closer than 8" on center and 2) it cannot be used with 2 of our 7 **Unicep** single-fixture track units.

Warranty Details

- This fixture is not suitable for use in direct sunlight, as under a skylight. Fixtures used in this way are not covered by our warranty.
- Our 5-year warranty does not include the provision of extraordinary means of access, e.g. scaffolding or Genie lifts, to service a product.

– see below for photometric reports –



PHOTOMETRIC REPORT with 15° reflector (tested per IESNA LM-79-2008)



Prorated from Verification Services Report No. 717366. Original test report furnished upon request.

Luminaire track-mounted LED accent light with a 15° reflector and black cross-baffle (NO LENS)
 Lamp Citizen LED, 5600 lumens, 3000K CCT
 Lamp Life rated 50.000 hours based on L70/B50 criteria. LM80 report by LED manufacturer furnished upon request

CANDLEPOWER DISTRIBUTION

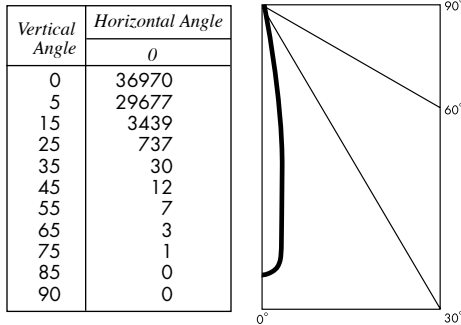

LUMINAIRE LIGHT OUTPUT AND EFFICACY

LED Module Type	Luminaire Light Output	Luminaire CBCP	Luminaire Efficacy (lumens/watt)	System Wattage
5600 Lumens 80 CRI (L56S)	3579	36,970	89	40
4300 Lumens 97 CRI (L43A)	2720*	28,097*	68*	40

*estimated values

PHOTOMETRIC REPORT with 21° reflector (tested per IESNA LM-79-2008)



Verification Services Report No. 717365. Original test report furnished upon request.

Luminaire track-mounted LED accent light with a 21° reflector and black cross-baffle (NO LENS)
 Lamp Citizen LED, 5600 lumens, 3000K Lamp Life..... see above

CANDLEPOWER DISTRIBUTION

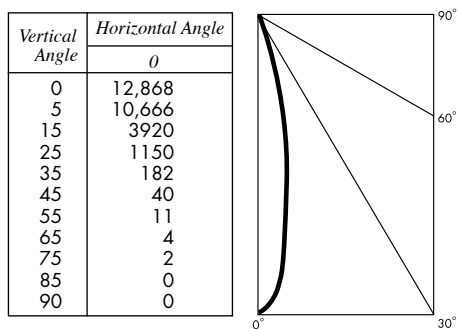

LUMINAIRE LIGHT OUTPUT AND EFFICACY

LED Module Type	Luminaire Light Output	Luminaire CBCP	Luminaire Efficacy (lumens/watt)	System Wattage
5600 Lumens 80 CRI (L56S)	2742	12,868	69	40
4300 Lumens 97 CRI (L43A)	2084*	9780*	52*	40

*estimated values

PHOTOMETRIC REPORT with 38° reflector (tested per IESNA LM-79-2008)



Verification Services Report No. 717367. Original test report furnished upon request.

Luminaire track-mounted LED accent light with a 38° reflector and black cross-baffle (NO LENS)
 Lamp Citizen LED, 5600 lumens, 3000K Lamp Life..... see above

CANDLEPOWER DISTRIBUTION

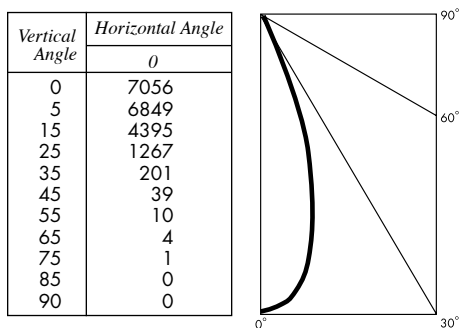

LUMINAIRE LIGHT OUTPUT AND EFFICACY

LED Module Type	Luminaire Light Output	Luminaire CBCP	Luminaire Efficacy (lumens/watt)	System Wattage
5600 Lumens 80 CRI (L56S)	2642	7056	66	40
4300 Lumens 97 CRI (L43A)	2008*	5363*	50*	40

*estimated values

PHOTOMETRIC REPORT with 15° reflector (tested per IESNA LM-79-2008)

Prorated from Verification Services Report No. 717362. Original test report furnished upon request.

Luminaire track-mounted LED accent light with a 15° reflector and black lens holder (NO LENS)

Lamp Citizen LED, 5600 lumens, 3000K CCT

Lamp Life rated 50,000 hours based on L70/B50 criteria. LM80 report by LED manufacturer furnished upon request

15°



CANDLEPOWER DISTRIBUTION

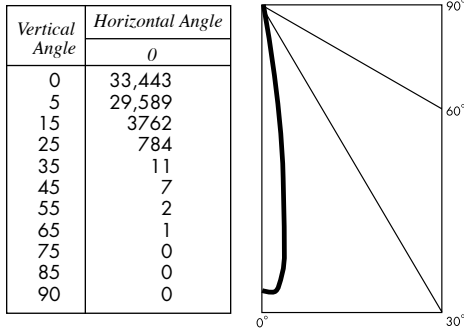

LUMINAIRE LIGHT OUTPUT AND EFFICACY

LED Module Type	Luminaire Light Output	Luminaire CBCP	Luminaire Efficacy (lumens/watt)	System Wattage
5600 Lumens 80 CRI (L56S)	3697	33,888	92	40
4300 Lumens 97 CRI (L43A)	2810*	25,755*	70*	40

*estimated values

PHOTOMETRIC REPORT with 21° reflector (tested per IESNA LM-79-2008)

Verification Services Report No. 717360. Original test report furnished upon request.

Luminaire track-mounted LED accent light with a 21° reflector and black lens holder (NO LENS)

Lamp Citizen LED, 5600 lumens, 3000K

Lamp Life see above

21°



CANDLEPOWER DISTRIBUTION

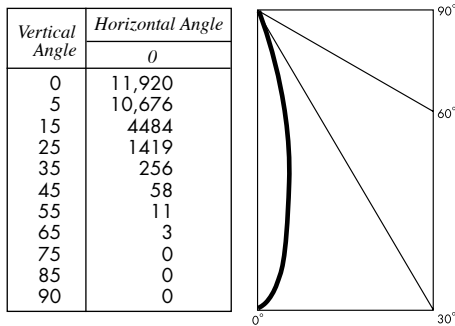

LUMINAIRE LIGHT OUTPUT AND EFFICACY

LED Module Type	Luminaire Light Output	Luminaire CBCP	Luminaire Efficacy (lumens/watt)	System Wattage
5600 Lumens 80 CRI (L56S)	3092	11,920	77	40
4300 Lumens 97 CRI (L43A)	2350*	9059*	59*	40

*estimated values

PHOTOMETRIC REPORT with 38° reflector (tested per IESNA LM-79-2008)

Verification Services Report No. 717363. Original test report furnished upon request.

Luminaire track-mounted LED accent light with a 38° reflector and black lens holder (NO LENS)

Lamp Citizen LED, 5600 lumens, 3000K

Lamp Life see above

38°



CANDLEPOWER DISTRIBUTION

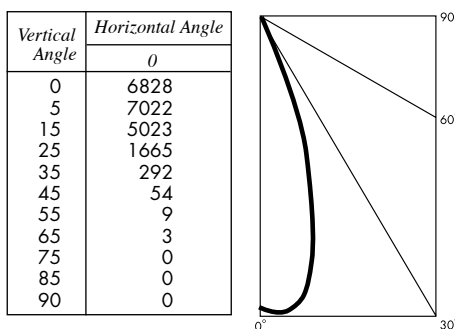

LUMINAIRE LIGHT OUTPUT AND EFFICACY

LED Module Type	Luminaire Light Output	Luminaire CBCP	Luminaire Efficacy (lumens/watt)	System Wattage
5600 Lumens 80 CRI (L56S)	3084	6828	77	40
4300 Lumens 97 CRI (L43A)	2344*	5189*	59*	40

*estimated values

STANDARD DRIVER INFORMATION (UL Class 2, dry and damp location)

Voltage	120	277
Input Watts (L56S/L43A)	40/40	40/40
Input Current(A) (L56S/L43A)	.33/.33	.14/.14
Output Current (mA)	350-940	350-940
Min. Power Factor	0.90	0.90
Operating Temperature Range (F)	-4 to 122	-4 to 122

LIGHT OUTPUT MULTIPLIER

LED Module Type	Light Output Multiplier
5600 Lumens 80 CRI (L56S)	1
4300 Lumens 97 CRI (L43A)	.76*